



# GST100 Intelligent Fire Alarm Control Panel



Installation and Operation Manual

Issue 2.06 June 2013

ERP:30309654

## CONTENTS

<b>Chapter 1 Brief Introduction .....</b>	<b>1</b>
<b>Chapter 2 Technical Specifications.....</b>	<b>2</b>
2.1 Operating Voltage.....	2
2.2 Standby Batteries .....	2
2.3 Detecting Loop Parameters.....	2
2.4 Output Loop Parameters .....	2
2.5 RS485 Communication Loop .....	3
2.6 Dimensions.....	3
<b>Chapter 3 Structure.....</b>	<b>4</b>
3.1 Appearance and Internal Structure.....	4
3.1.1 Front Panel .....	4
3.1.2 LEDs .....	5
3.1.3 Keys .....	7
3.2 Configuration .....	7
3.2.1 Typical Configuration .....	7
3.2.2 Optional Units .....	8
3.3 Periphery Devices .....	8
3.3.1 A Series of Intelligent Fire Detectors .....	8
3.3.2 Manual Call Points .....	8
3.3.3 Sounder Strobes .....	8
3.3.4 Loop Isolator .....	8
3.3.5 Repeater Panel .....	8
<b>Chapter 4 Installation and Commission .....</b>	<b>9</b>
4.1 Checking.....	9
4.2 Installation.....	9
4.3 Power-up Self-test.....	9
4.4 Connections of Periphery Devices .....	9
4.4.1 Connection of SOUNDER OUTPUT Loop .....	10
4.4.2 Loop Connection.....	11
4.4.3 Connection of Communication Loop .....	11
4.5 Commission.....	12
4.5.1 Connection checking .....	12
4.5.2 Registering Devices.....	12
4.5.3 Defining Devices.....	12
<b>Chapter 5 Display and Disposal of System Information.....</b>	<b>13</b>
5.1 Message display rules .....	13
5.1.1 Description of Displayed messages .....	13
5.2 Rules for Sound Indication .....	14
5.3 System Normal Message .....	14
5.4 Fire Message.....	14
5.4.1 Fire Message Display .....	14
5.4.2 Disposal of Fire Message .....	15

5.5 Fault Message .....	15
5.5.1 Fault Message Display .....	15
5.5.2 Disposal of Fault Message .....	16
5.6 Pre-alarm Message .....	16
5.6.1 Operation of Delay Mode.....	16
5.6.2 The First Stage.....	17
5.6.3 The Second Stage .....	17
5.7 Supervisory Messages .....	17
5.8 Action Message .....	18
5.9 Delay Message.....	18
5.10 Disable Messages .....	19
<b>Chapter 6 Users' Guide.....</b>	<b>20</b>
6.1 Rules for Menu Operation .....	20
6.2 Rules for Data Input.....	20
6.3 Viewing Messages.....	20
6.3.1 Viewing All Messages.....	20
6.3.2 Viewing Fire Messages.....	21
6.4 Viewing System Devices .....	21
6.4.1 Loop Devices .....	21
6.4.2 Viewing Network FACP.....	22
6.4.3 Viewing Repeater Panels .....	22
6.5 Disabling and Enabling Devices.....	22
6.5.1 Disabling / Enabling a Zone.....	23
6.5.2 Disabling / Enabling a device .....	24
6.5.3 Disabling / Enabling an Output .....	24
6.5.4 Disabling / Enabling Pre-alarm .....	25
6.5.5 Disabling / Enabling Output Delay.....	26
6.6 Users Settings .....	26
6.6.1 Printer Setup .....	26
6.6.2 Time Setup.....	27
6.6.3 Delay Setup .....	28
6.6.4 Network Setup .....	28
6.7 Evacuate.....	28
6.8 Alarm Silence.....	28
6.9 Reset .....	28
6.10 Unlocking and Locking the Keypad .....	29
6.10.1 Unlocking the Keypad.....	29
6.10.2 Locking the Keypad .....	29
<b>Chapter 7 System Operator's Guide .....</b>	<b>30</b>
7.1 System Status Setup .....	30
7.2 Device Definition.....	30
7.3 Device Registration .....	31
7.4 Password Setting.....	32
7.4.1 Classification of the passwords .....	32

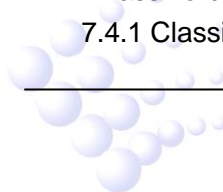

---

7.4.2 Modification of the password .....	32
7.5 Device Modification .....	33
7.5.1 Code Modification .....	33
7.5.2 Sensitivity Modification .....	34
7.6 Device Monitoring.....	34
<b>Chapter 8 Networking .....</b>	<b>36</b>
8.1 General Description.....	36
8.2 Networking the FACP .....	36
8.2.1 Network of GST Series Panels.....	36
8.2.2 Connecting with Repeater Panels .....	36
8.3 Networking Method .....	36
8.3.1 GST Network .....	36
8.3.2 Connecting with Repeater Panels .....	37
8.4 Display of Network Messages.....	37
8.4.1 Network Fault.....	37
8.4.2 Display of Network Messages .....	38
<b>Chapter 9 Calculation of Battery Capacity .....</b>	<b>39</b>
<b>Chapter 10 Troubleshooting and Regular Inspection .....</b>	<b>40</b>
10.1 Common Disposal .....	40
10.2 Maintenance of Printer .....	40
<b>Appendix 1 Internal Connection Diagram .....</b>	<b>42</b>
<b>Appendix 2 Device Type List .....</b>	<b>43</b>

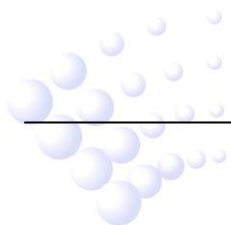

## Chapter 1 Brief Introduction

GST100 Intelligent Fire Alarm Control Panel is a mini- panel designed by EN54-2. It features simple installation, operation and maintenance, which make it ideal for smaller systems.

- 1 Maximum 8 detection zones, each with independent fire LED, fault/disable LED and zone label.
- 2 Class A loop which is able to connect maximum 128 addressable devices.
- 3 122×32 lattice LCD assisting the LED indicators to display important information.
- 4 Non-volatile memory ensuring system data not lost on shutdown of power.
- 5 Delayed output effectively reducing false action of ALARM OUTPUT and SOUNDER OUTPUT (R+ and R-) contact.
- 6 3 relay outputs available which are SOUNDER OUTPUT (R+ and R-), ALARM OUTPUT (shared by fire alarm and supervisory output) and FAULT OUTPUT.
- 7 RS485 communication interface for networking.

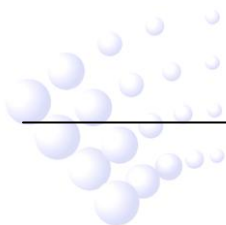

## Chapter 2 Technical Specifications

### 2.1 Operating Voltage

- ✧ Input Voltage: 230V AC  $\begin{matrix} +10\% \\ -15\% \end{matrix}$
- ✧ Frequency: 50Hz
- ✧ Input Current: 0.2A
- ✧ Fuse: 2A
- ✧ Recommended Wiring: 1.5mm<sup>2</sup> or above shield cable, complying with local installation code.

### 2.2 Standby Batteries

- ✧ Maximum Charge Current: 0.3A±0.05A
- ✧ Maximum Charge Voltage: 27.5V±0.5V
- ✧ Type: Sealed lead acid batteries
- ✧ Maximum Battery Capacity: 24V/7Ah
- ✧ Recommended Wiring:  
GST FireCable ® 2E/1.5    2 core and Earth 1.5mm<sup>2</sup> CSA  
Pirelli Cable Limited FP200 FLEX 2 core and Earth 1.5mm<sup>2</sup> CSA

### 2.3 Detecting Loop Parameters

- ✧ LOOP OUT (+, -): Polarized signal cable from the FACP connecting with up to 128 addressable devices.
- ✧ LOOP IN (+, -): Polarized signal cable returning to the FACP.
- ✧ Type of loop: Class A
- ✧ Recommended Wiring:  
GST FireCable ® 2E/1.0    2 core and Earth 1mm<sup>2</sup> CSA  
Pirelli Cable Limited FP200 FLEX 2 core and Earth 1mm<sup>2</sup> CSA

### 2.4 Output Loop Parameters

Recommended Wiring:

GST FireCable ® 2E/1.0    2 core and Earth 1mm<sup>2</sup> CSA  
Pirelli Cable Limited FP200 FLEX 2 core and Earth 1mm<sup>2</sup> CSA

#### 1 SOUNDER OUTPUT (R+, R-)

- ✧ Output Voltage: 21VDC ~27VDC

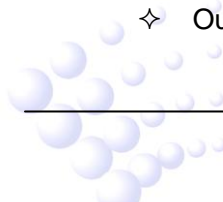

- ◇ Output Current: 0~500mA
- ◇ Terminal Resistor: 4.7K
- 2 ALARM OUTPUT (NC, COM, NO)
  - ◇ Contact Capacity: 24VDC @1.0A
  - ◇ In case of a fire alarm or supervisory condition, NC and COM open, NO and COM close.
- 3 FAULT OUTPUT (NC, COM, NO)
  - ◇ Contact Capacity: 24VDC @1.0A
  - ◇ In case of a fault condition, NC and COM open, NO and COM close.

## 2.5 RS485 Communication Loop

- ◇ A, B: RS485 communication cable, for connecting with up to 32 network fire alarm control panels and 64 repeater panels.
- ◇ Recommended Wiring:
  - GST FireCable ® 2E/1.0 2 core and Earth 1mm<sup>2</sup> CSA
  - Pirelli Cable Limited FP200 FLEX 2 core and Earth 1mm<sup>2</sup> CSA

## 2.6 Dimensions

300mm×210mm×91mm

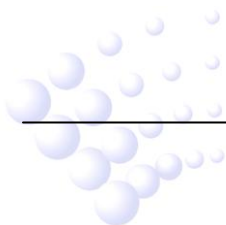

## Chapter 3 Structure

### 3.1 Appearance and Internal Structure

GST100 is wall-mounted. Its appearance, internal structure and connection are shown in Fig. 3-1 and Fig. 3-2.

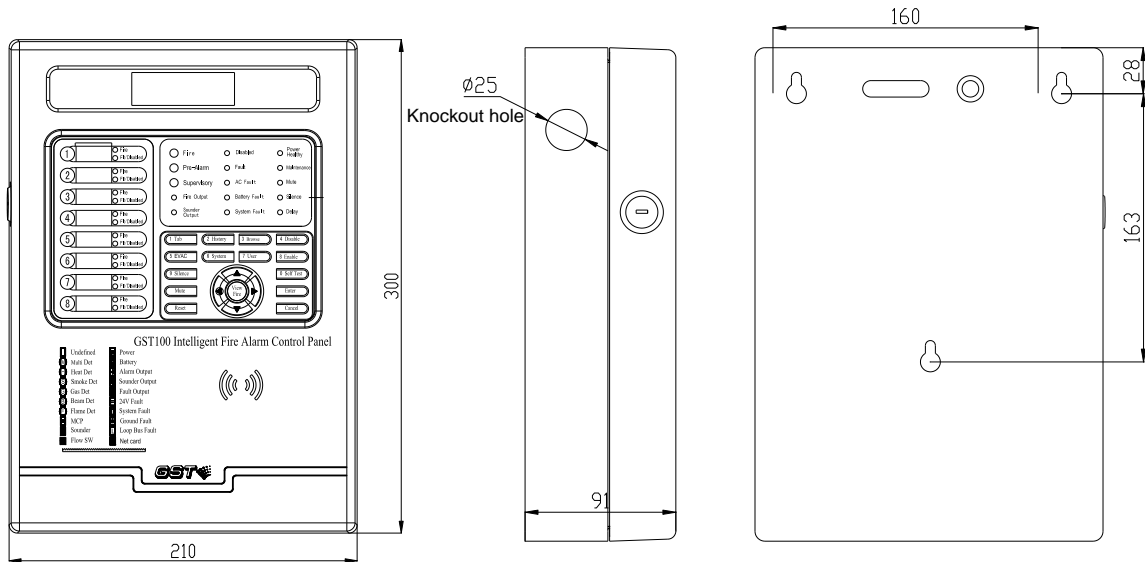

Fig. 3-1

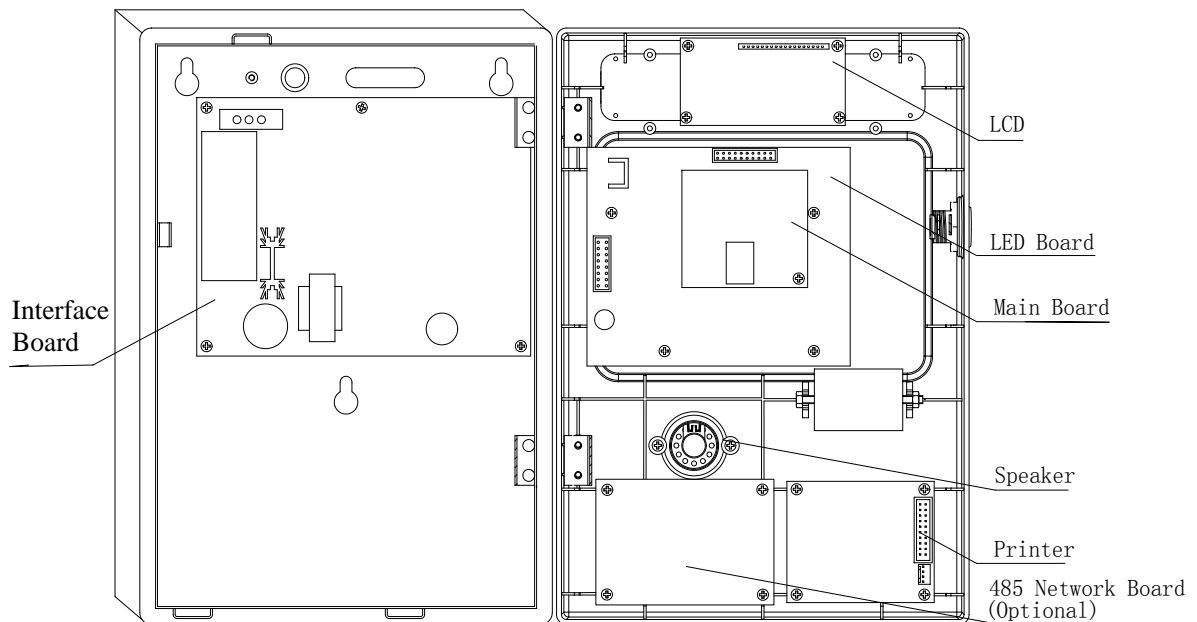
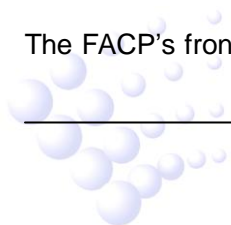

Fig. 3-2

#### 3.1.1 Front Panel

The FACP's front panel consists of LCD, general LEDs, zonal LEDs, Keypad and Printer as





shown in Fig. 3-3.

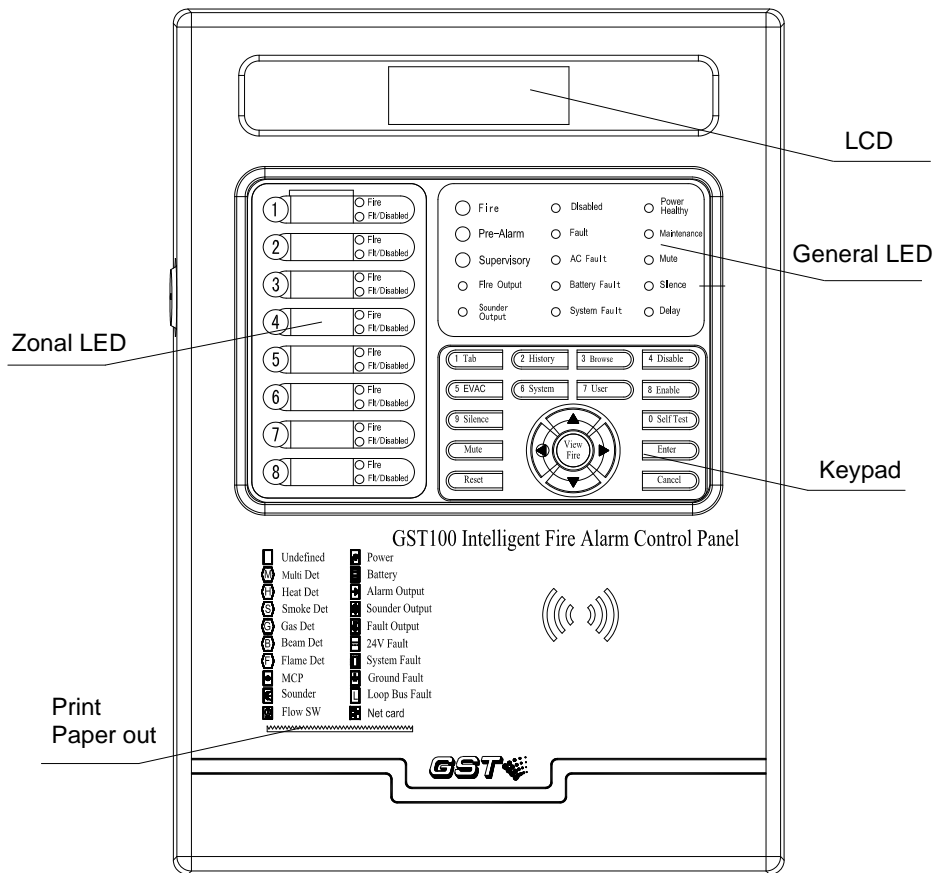

Fig. 3-3

### 3.1.2 LEDs

LED	Colour	Function	How to clear
<b>General LED</b>			
Fire	Red	Turns on when a fire alarm is detected	Verify the cause of the event and then reset the FACP.
Pre-Alarm	Red	Turns on when there is a detector in the system in pre-alarm state	Goes off when the pre-alarm changes to a fire alarm or when the panel is reset
Supervisory	Red	Turns on when a gas detector or water flow indicator alarms	Verify the cause of the event and then reset the FACP.
Fire Output	Red & Green	① Red LED illuminates when there is alarm output (fire alarm or supervisory) ② Red and green LED both illuminate when the alarm output (fire alarm and supervisory) is disabled.	① Red LED goes off when the control panel is reset. ② Both LED go off when any of the alarm outputs (fire alarm or supervisory) is enabled.
SOUNDER	Red &	① Red LED illuminates when the	① Red LED goes off when the

OUTPUT	Green	<p>sounder (R+, R-) outputs.</p> <p>② Both LED illuminate when SOUNDER OUTPUT (R+, R-) is disabled.</p> <p>③ Both LED flash when the SOUNDER OUTPUT (R+, R-) is in trouble condition.</p>	<p>panel is reset.</p> <p>② Both LED go off when the SOUNDER OUTPUT (R+, R-) is enabled.</p> <p>③ Both LED go off when the trouble condition is cleared.</p>
Disabled	Yellow	Turns on when there is a connected device or an output or the delay mode is disabled.	Enable all devices or outputs, refer to Section 6.5
Fault	Yellow	Turns on when a trouble condition is detected.	Remove the cause of the trouble.
AC Fault	Yellow	Turns on when 230VAC power supply is down or damaged.	Remove the cause of the trouble.
Battery Fault	Yellow	Turns on when the standby battery is under-voltage or damaged.	Remove the cause of the trouble.
System Fault	Yellow	<p>① Illuminates when the memory of the panel is in trouble.</p> <p>② Flashes when system program cannot be executed.</p>	Remove the cause of the trouble.
Power Healthy	Green	Illuminates when power supply works normally.	
Maintenance	Yellow	Illuminates when a detector reports dirty.	Clean the detector and then reset the panel.
Mute	Yellow	Illuminates when the panel's speaker is turned off.	<p>Verify the cause of the event and reset the control panel.</p> <p>Note: If there is new fire alarm, the speaker will be re-activated and this LED will go off.</p>
Silence	Yellow	Illuminates when the sounders are silenced or when the SOUNDER OUTPUT (R+, R-) is disabled.	<p>Verify the cause of the event and reset the control panel.</p> <p>Note: If there is new fire alarm or the <i>Silence</i> key is pressed again, the sounder or SOUNDER OUTPUT will be re-activated and this LED goes off.</p>
Delay	Yellow	Illuminates when there is a sounder or an output in delay mode.	<p>Verify the cause of the event.</p> <p>This LED goes off when the panel is reset or the delay time expires.</p>
<b>Zonal LED</b>			
Fire	Red	Turns on when a device of the zone alarms fire.	Verify the cause of the event and then reset the FACP.
Fit/Disabled	Yellow	<p>① Flashes if a device of the zone is in trouble condition.</p> <p>② Illuminates if all devices of the zone are disabled.</p>	<p>① Remove the cause of the trouble.</p> <p>② Enable all devices of the zone.</p>

### 3.1.3 Keys

Key	Function
Tab	Changing the display among different windows when there are multiple messages.
History	Viewing the running records and fire alarm records.
Browse	Viewing detailed information of on-line loop devices, network panels and repeaters.
Disable	Disabling zone, individual device, output, output delay or pre-alarm.
Enable	Enabling zone, individual device, output, output delay or pre-alarm.
System	For the administrator to define, register, monitor and modify devices and modify passwords.
User	For the user to set the printing mode, system time, delay time and network mode.
EVAC	Activating all sounders to warn people to evacuate.
Silence	Silencing the sounders and closing the SOUNDER OUTPUT. Pressing this key again can resume the silenced sounders and sounders.
Mute	Silencing the speaker of the panel.
SelfTest	Self-testing the LCD, speaker and all LEDs.
Reset	Resetting the panel.
Enter	For entering the selected menu and acknowledging the modifications.
Cancel	For returning to the previous menu.
View Fire	Going directly to fire alarm display window from any other current windows.
Navigation Keys	Changing among different messages or move among different items of the same type of message. Changing from different menu items. Changing from input boxes in data input or changing the cursor position.
0-9	For inputting number. For menu selection, pressing the number will enter corresponding screen.

## 3.2 Configuration

### 3.2.1 Typical Configuration

A typical FACP consists of main board, LED board, interface board and display area.

#### ✧ Main board

Main board is the core of the FACP, which contains CPU and interfaces to other main parts and optional parts.

#### ✧ LED/keypad board

This is the control board for the LED indicators and keypad operation.

#### ✧ Interface board

The interface board includes power supply system and signal interface. The power supply provides voltage for the main board, signal interface and printer. It's designed with power-down backup to ensure reliable system running. The signal interface has loop interface, SOUNDER OUTPUT (R+, R-), ALARM OUTPUT and FAULT OUTPUT

port to connect loop devices with the panel.

✧ **Display area**

This part is used to indicate and display different status of the system, and enables relative operations through keypad (browsing, setting, printing and etc).

### 3.2.2 Optional Units

✧ **GST-GMP-16 Printer**

It is a built-in mini-printer. It can print all ASCII code characters with dot matrix printing.

✧ **Network board**

The control panel provides a multi-functional communication port for networking GST series fire alarm control panels and repeater panels via a 485 card.

## 3.3 Periphery Devices

### 3.3.1 A Series of Intelligent Fire Detectors

The FACP can connect with a series of GST fire detectors mounted in the protected area to transmit messages to the FACP through Class A loop. Every detector has its own address with which the FACP can supervise the information of alarm, fault, and normal status of the detectors.

### 3.3.2 Manual Call Points

A series of GST manual call point can be connected to the loop of GST100. When fire is confirmed manually, pressing the glass on the MCP, alarm signal can be sent to the FACP. After receiving the alarm signal, the FACP will show the number and location of the MCP, and sound alarm.

### 3.3.3 Sounder Strobes

Sounder strobe is a kind of audible/ visual alarm device installed in the protected area, which can be activated by the FACP at the fire control center or by manual call points. A series of GST addressable sounder strobes can be connected to the loop of GST100. After activated, it will generate strong audible/ visual alarm signal.

### 3.3.4 Loop Isolator

Loop Isolator can remove the shorted part of loop from the whole system to ensure normal operation of other devices and to ascertain the location of the part in fault. After the faulty part is repaired, the loop isolator can automatically reset the removed part into the system.

### 3.3.5 Repeater Panel

GST852RP and GST8903 Repeater Panel can be connected with the FACP via 485 network card. When one or more detectors alarm fire, the repeater panel can display the location and alarm message of the detectors with audible and visual signals. Through communication loop, it can be connected with FACP, disposing and displaying the data from the FACP.

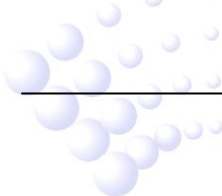

## Chapter 4 Installation and Commission

### 4.1 Checking

Please check the following items of the FACP before installation.

- ✧ Check project configuration

Check the configuration according to packing list. The main items are: Installation and Operation Manual, and keys to the FACP, etc.

- ✧ Check internal configurations and interconnections

The FACP is installed and wired with all parts (including optional parts specially ordered) at the factory. Please check the connection of all the parts, including connection of main board with LED/key board, LED/key board with interface board, and speaker with LED/key board. Please refer to Appendix 1 Internal connection diagram.

### 4.2 Installation

Mounting Method: Wall mounted

Mounting Hole Distance: 160mm

Operating Temperature: 0°C ~ +40°C

Relative Humidity ≤95%, non condensing

### 4.3 Power-up Self-test

After the FACP is installed, power it up for self-test to see

- ✧ If the LCD is normal;
- ✧ If all LED indicators are able to illuminate;
- ✧ If the speaker can give different kinds of obvious loud alarming sounds, and
- ✧ Observe if there's trouble with the power supply and if the keypad gives tick-tick sound after entering normal monitor state.

### 4.4 Connections of Periphery Devices

**Warning: After power-up self-test, please disconnect the power before connecting periphery devices!**

Terminals of the FACP are shown in Fig. 4-1. Please refer to Appendix 1 for the position of terminals on the PCB.

Interface board:

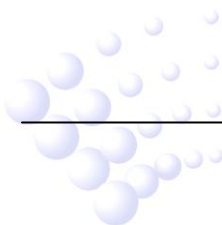

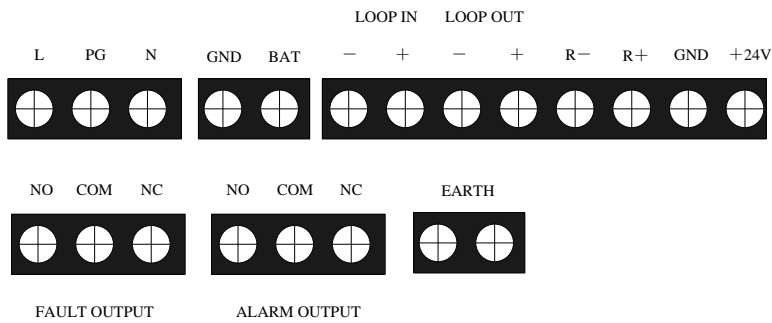

485 network board:

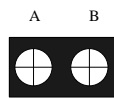

Fig. 4-1

**L, PG, N:** 230VAC terminal and ground terminal for chassis protection.

**BAT, GND:** 24VDC battery input terminal.

**LOOP IN, LOOP OUT:** Class A loop, able to connect up to 128 addressable devices. The loop device protected by isolators will not lose when short or broken circuit occurs, and the FACP reports the loop fault.

**R-, R+:** SOUNDER OUTPUT terminal. It outputs when a fire alarm comes, which can be stopped by pressing the *Silence* key. It can be disabled, and does not output when fire alarm occurs in disabled state. The FACP report a fault when connected cable in short or open circuit.

**+24V, GND:** 24VDC auxiliary power output, the maximum output current is 500mA.

**FAULT OUTPUT:** Voltage-free contact output, COM is the common terminal, NC is normally closed contact, NO is normally open contact. When there is fault signal, normally open contact is closed; when the fault is removed, it opens. It can be disabled, and does not output when fire alarm occurs in disabled state.

**ALARM OUTPUT:** Passive contact output. COM is the common terminal, NC is normally closed contact, NO is normally open contact. When there is fire or supervisory signal, the normally open contact is closed. It can be disabled, and does not output when fire alarm or supervisory condition occurs in disabled state.

**EARTH:** Terminal for checking ground fault, which is enabled by shorting it with a cable.

**A, B:** RS485 loop output terminal for connecting GST network panels and repeater panels.

#### 4.4.1 Connection of SOUNDER OUTPUT Loop

The connection of SOUNDER OUTPUT loop is shown as Fig. 4-2.

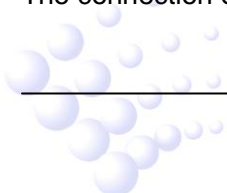

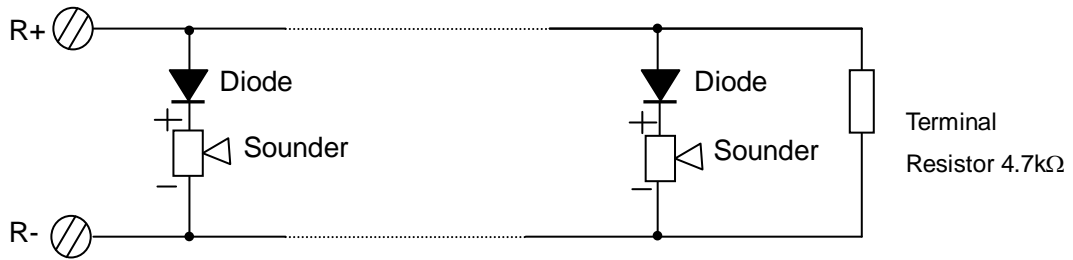

Fig. 4-2

Description: Remove the terminal resistor. Connect the cable in correct polarization. Add a 4.7kΩ resistor to the end of each loop.

**NOTE: The sounders are polarized. Note polarization in connection. The maximum current is 500mA. Do not overload with sounders and strobes.**

#### 4.4.2 Loop Connection

The connection of loop bus is shown as Fig. 4-3.

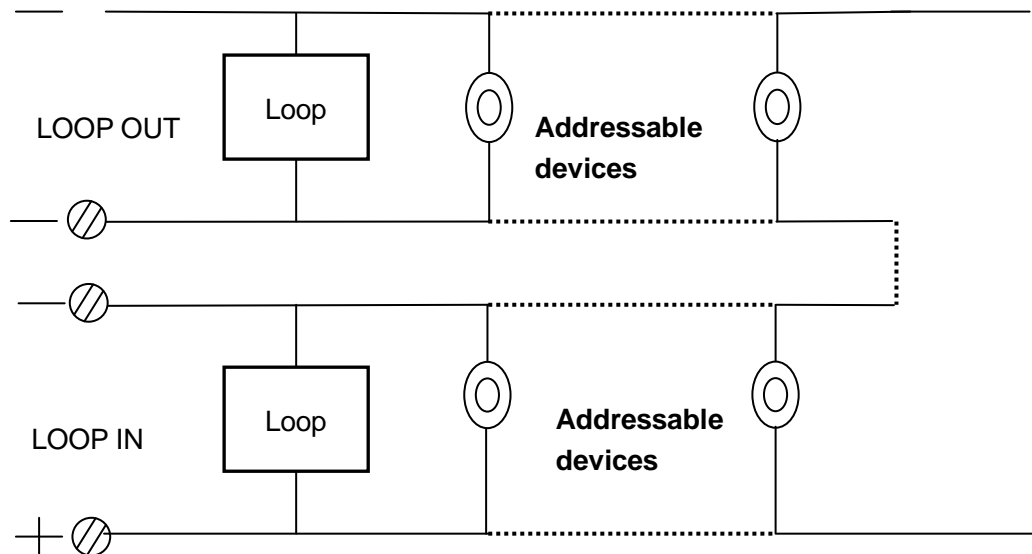
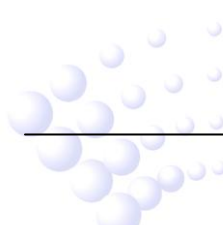

Fig. 4-3

#### 4.4.3 Connection of Communication Loop



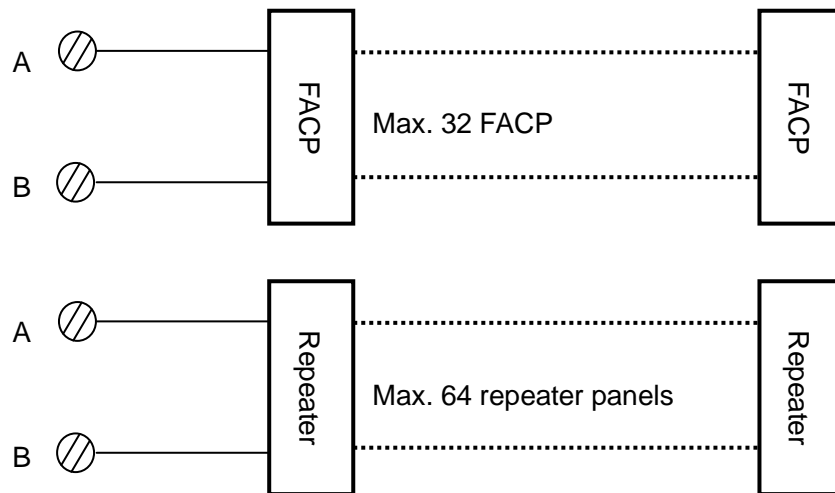

Fig. 4-4

## 4.5 Commission

### 4.5.1 Connection checking

Check the loop conditions, measure the insulation resistance between the loop and ground, and inspect loop load, of which the insulation resistance should be more than  $20M\Omega$ , and loop load more than  $1k\Omega$ . Cross cable resistance is equal to the terminal resistance.

### 4.5.2 Registering Devices

Press *System* key and input password (system default is no password), then press *Enter* to access system menu. Then reboot the FACP, it will automatically register system devices, and check if the number, code and status comply with project design.

The FACP will automatically identify the loop device if it is first registered. The devices can be assigned into zones by their codes. The user can put number 1-15 into the same zone; number 16-30 into another zone...and etc. Devices after No. 120, which are sounders only, are usually installed in the common zone. In addition, a sounder will be assigned to a zone.

### 4.5.3 Defining Devices

Zones can be re-assigned according to field situations. The system does not limit the number and code of devices for each zone. The sounders can be addressed to any number within 1~242.

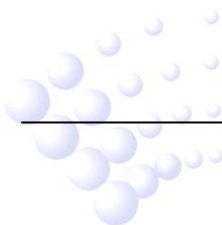



## Chapter 5 Display and Disposal of System Information

The FACP can start operation after installed following instructions in Chapter 4. Turn on its power supply, it will start self-test and enter normal monitor status. It displays system normal screen if it works normally. If there are any problems, corresponding display will appear on the screen.

### 5.1 Message display rules

The FACP can display the following types of message: fire alarm, pre-alarm, supervisory, action, delay, fault and disable.

#### 5.1.1 Description of Displayed messages

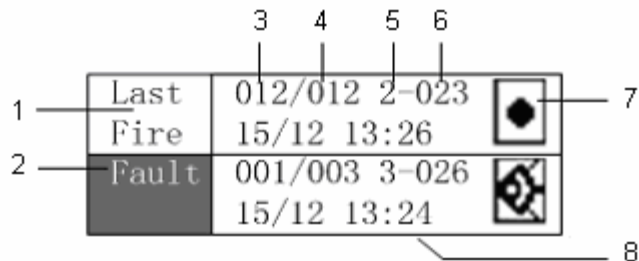

Fig. 5-1

In the above picture,

1 means there is fire alarm in the system, the top part of the screen will always display the latest fire alarm.

2 Current message type. You can change to displaying other messages or move among different items by pressing *Tab* key.

3 Serial number of the current message.

4 Total number of this type of message.

5 Zone number of the message.

6 Device code of message.

7 Mark of the device, please refer to Appendix 2.

8 Occurring time of the message (Day/Month Hour : Minute).

If the position of 5 and 6 are “-“, this message is the panel’s internal message, which could be AC fault, battery fault, system fault, ALARM OUTPUT, SOUNDER OUTPUT or FAULT OUTPUT.

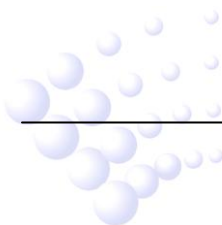

## 5.2 Rules for Sound Indication

The FACP will sound to indicate fire alarm or fault messages. In case of multiple messages, the FACP will sound by the following priority:

- (1) Fire alarm: fire truck sound
- (2) Supervisory: fire truck sound
- (3) Action: quick police car sound
- (4) Fault: Ambulance sound

Pressing *Mute* can stop the sound of the FACP; In mute state, *Mute* LED illuminates, and the speaker stops sounding. Pressing *Mute* again, the FACP is still in mute state. It will sound by priority when new event appears. If new alarm occurs, the *Mute* LED is off, and the corresponding sound of the alarm will be heard. For instance, if a new fault condition occurs in mute state, the FACP will generate a fault sound.

## 5.3 System Normal Message

Fig. 5-2 shows the system normal screen.

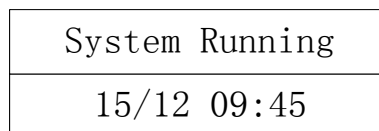

Fig. 5-2

## 5.4 Fire Message

### 5.4.1 Fire Message Display

GST100 control panel will generate alarm signal in 10 seconds when a detector alarms fire or a manual call point is pressed.

- (1) The LCD displays fire messages shown as Fig. 5-3.
- (2) The speaker gives fire alarm sound (fire truck sound). The general *Fire* LED and the zonal *Fire* LED illuminate.
- (3) The sounders in this zone and the common zone are triggered.
- (4) When fire output is enabled, the normally open contact of ALARM OUTPUT (NO, COM) is closed and the normally closed contact (NC, COM) is open. The *Fire Output* LED illuminates. When SOUNDER OUTPUT (R+, R-) is enabled, the R+ and R- are closed to start output. The *Fire Output* or *SOUNDER OUTPUT* LED lights red.

Please refer to Section 6.5.3 for the operation method to ALARM OUTPUT and SOUNDER OUTPUT (R+, R-).

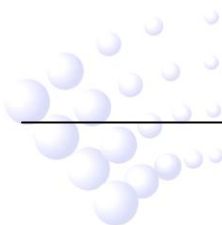



Last	043/043 2-023	
Fire	15/12 13:26	
Fire	001/043 2-031	
	15/12 13:26	

Fig. 5-3

## 5.4.2 Disposal of Fire Message

When fire alarm occurs, first find out the location according to the information shown on the FACP to verify if it's a real fire. If it's real, you can take the following measures.

- (1) Press *EVAC* key to warn people to evacuate.
- (2) Organize specially trained personnel to try to control the fire.
- (3) Call the fire brigade.

If it is false, please take the following measures.

- (1) Press *Silence* to stop the sounders.
- (2) Remove the factors that caused the false alarm. Press *Reset* to make the control panel back to normal state.
- (3) If the false alarm is caused by the malfunction of fire detection device, disable it and inform the manufacturer for repair.

## 5.5 Fault Message

### 5.5.1 Fault Message Display

When fault occurs, the FACP will give fault signal in 100 seconds.

- (1) The LCD displays the fault message as shown in Fig. 5-4.
- (2) The speaker of the FACP gives fault sound ( ambulance sound ) . The common *Fault* LED illuminates.

If fault output is enabled, the normally open contact of FAULT OUTPUT contact (NO, COM) is closed, and the normally closed contact is open.

The FACP will indicate differently for different type of fault message.

- ✧ If a field device is in trouble, the zonal *Fit/Disable* LED flashes.
- ✧ If the AC power is down, the FACP reports AC fault, the *AC Fault* LED illuminates.
- ✧ If the battery voltage is lower than 18V, the *Battery Fault* LED illuminates.
- ✧ If it's a fault with the memory, the *System Fault* LED illuminates. If the program cannot be executed because of an internal fault or the damaged CPU, the *Fault* and *System Fault* LED illuminate intermittently, and the speaker gives tick-tick sound.
- ✧ If one of the detectors report dirty, the LCD displays "Dust" at the section of current

message type, and *Fault* and *Maintenance* LED illuminate.



Fault	001/002 2-125 15/12 13:28	
Dust	002/002 2-017 15/12 13:50	

Fig. 5-4

### 5.5.2 Disposal of Fault Message

There are two types of fault in the system. One is control system fault such as AC or battery fault and loop fault; the other is the fault with field devices, such as detector fault and dirty.

- (1) If the AC power is down, the battery should be used. Please note the FACP shall not be powered with battery longer than the battery's maximum working time. The FACP shall be shut down if the time limit is reached in order to avoid any damage to the battery. Please refer to Chapter 9 for the calculation method of battery capacity.
- (2) If it is system fault, check and repair in time. If the FACP needs to be shut down, please make detailed records.
- (3) If it is field device fault, please repair it immediately. You can disable it if the problem cannot be immediately resolved, and then enable it when the fault is cleared.
- (4) If the detector reports dirty, please clean it in time, otherwise the detector cannot operate normally.

## 5.6 Pre-alarm Message

### 5.6.1 Operation of Delay Mode

- (1) If pre-alarm is enabled, the FACP can work at delay mode.
- (2) In delay mode, if there is a fire alarm from a zone, the FACP will report as a pre-alarm, but will delay the start of sounders and ALARM OUTPUT and SOUNDER OUTPUT contact (R+, R-). If no measure is taken during the delay period, the FACP will then report a fire alarm.
- (3) If the FACP resets the detector reporting a pre-alarm, the detector will resume monitor state.
- (4) During the delay period, if there is a new fire alarm detected from the same zone, the control panel will then report a fire alarm and start the sounders ALARM OUTPUT and SOUNDER OUTPUT (R+, R-) immediately.
- (5) The delay mode can only be effective when pre-alarm function is enabled. Please refer to Section 6.5.4 for detailed descriptions.
- (6) There are two stages for delay mode, the maximum time of the two stages can be set in delay time setting, refer to Section 6.6.3.

### 5.6.2 The First Stage

- (1) In delay mode, the FACP enters the first stage on receiving the first fire alarm signal. It will give fire alarm sound (fire truck sound). The LCD displays the message of that detector (zone, code and device type), and the delay time which decreases by second (Fig. 5-5).
- (2) If, during the delay period, the pre-alarm is not acknowledged by pressing *Enter*, the FACP will report a fire alarm and activate the sounders, ALARM OUTPUT and SOUNDER OUTPUT contact (R+, R-) on expiry of the delay time.
- (3) If *Enter* is pressed during the delay period, the FACP enters the second stage.

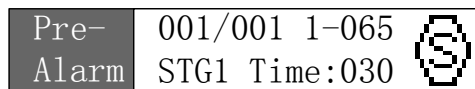

Fig. 5-5

### 5.6.3 The Second Stage

- (1) Entering the second stage, the delay time for the second stage starts to decrease by second.
- (2) If the FACP is not reset by pressing *Reset* key, it will then activate the sounders, ALARM OUTPUT and SOUNDER OUTPUT contact (R+, R-) on expiry of the delay time for the second stage.

During the second stage, you can check the zone where the alarm comes from and verify the cause of the alarm.

- (1) If it's a false alarm, you can reset the FACP through *Reset* key.
- (2) If it's verified to be a real fire, you can press the manual call point, and the FACP will then activate the sounders, ALARM OUTPUT and SOUNDER OUTPUT contact (R+, R-) immediately. (Please note that under any condition, the FACP will activate the sounders, ALARM OUTPUT and SOUNDER OUTPUT contact (R+, R-) immediately when the delay time of the second stage expires.)

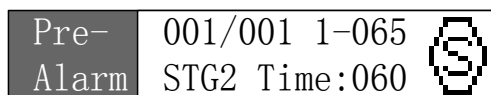
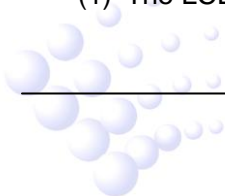

Fig. 5-6

## 5.7 Supervisory Messages

The FACP will give supervisory message when there is an alarm from a gas detector or an action by water flow indicator.

- (1) The LCD displays supervisory message shown as in Fig. 5-7.



- (2) The speaker gives supervisory sound (fire truck sound). The *Supervisory* LED illuminates.
- (3) The sounder of this zone and the common zone will be triggered.
- (4) If supervisory is enabled, the normally open contact of ALARM OUTPUT relay (NO, COM) is closed, and the normally closed contact (NC, COM) open, the *Fire Output* LED lights red. If SOUNDER OUTPUT is enabled, the R+ and R- contact is closed to output, and *SOUNDER OUTPUT* LED lights red.

Please refer to Section 6.5.3 for the operation methods to enable the supervisory output and SOUNDER OUTPUT.



Abno- rma1	001/002 2-065 15/12 13:26	
Abno- rma1	002/002 3-059 15/12 13:35	

Fig. 5-7

## 5.8 Action Message

When there is a fire alarm and the zonal sounder is activated or the ALARM OUTPUT, SOUNDER OUTPUT(R+, R-) or FAULT OUTPUT are triggered, the FACP will give the following action messages:

- (1) The LCD displays the action messages as in Fig. 5-8.
- (2) The speaker gives action sound (quick police car sound).
- (3) Pressing *Silence* can close the sounder and SOUNDER OUTPUT (R+, R-). Pressing *Silence* again can re-start the sounder and SOUNDER OUTPUT(R+, R-).



Acti- on	001/002 3-039 15/12 08:26	
Acti- on	002/002 ----- 15/12 10:30	

Fig. 5-8

## 5.9 Delay Message

The output of the FACP can be delayed. Please refer to Section 6.5.5 for operation of enabling /disabling the output delay. The delay time can be set under Unser\Delay Setup menu, please refer to Section 6.6.3.

When an alarm comes while the output delay is enabled and the zonal delay time is not 0, the FACP will automatically delay the start of the zonal sounder. If the common zone delay time is not 0, the FACP will automatically delay the start of the common zone sounders. The LCD will display the delay message shown as in Fig. 5-9. The *Delay* LED illuminates. On expiry of the delay time, the *Delay* LED goes off, the sounder starts and the FACP gives action messages.

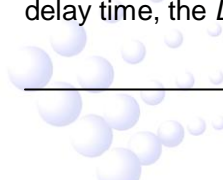



Delay	001/002 2-115 Time:025	
Delay	002/002 ----- Time:035	

Fig. 5-9

The messages on the screen mean that there are 2 devices being delayed. The sounder number 115 in Zone 2 will activate after 25 seconds and SOUNDER OUTPUT (R+. R-) will activate after 35 seconds. The delay time on the screen will decrease as the time passes.

During the delay period, pressing a manual call point will stop the delay and start the sounders, ALARM OUTPUT and SOUNDER OUTPUT contact (R+, R-).

### 5.10 Disable Messages

When there are problems with connected devices, it may be necessary to disable them for repair, and then enable them after repairing or replacing. When there is a disabled device, the FACP gives disable message.

- (1) The LCD displays disabled messages as in Fig. 5-10.
- (2) *Disabled* LED illuminates.
- (3) If all devices of a zone are disabled, the zonal *Flt/Disabled* LED illuminates.



Dis-abled	001/002 2-015 15/12 08:26	
Dis-abled	002/002 1-001 15/12 10:30	

Fig. 5-10

During the disabled period, the disabled part doesn't work which will affect the system performance. Please have them repaired or replaced as soon as possible. In the mean time, more attention shall be paid to the area of the disabled devices to avoid and potential risks.

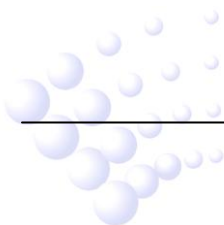

## Chapter 6 Users' Guide

### 6.1 Rules for Menu Operation

There are two methods to access the menu:

- (1) Pressing the corresponding number on the keypad.
- (2) Pressing the up and down key to highlight the menu item, and then press *Enter*.

### 6.2 Rules for Data Input

There is a cursor on the screen at the position to input data. Pressing the left and right key can move the position of the cursor. If there are multiple sections, pressing the up and down key can move the cursor among sections. You can also modify the data by moving the cursor during data input. Wherever the cursor is, pressing *Enter* will save all input data, and pressing *Cancel* will exit without saving any data.

### 6.3 Viewing Messages

The LCD will display the history records as shown in Fig. 6-1 after pressing *History* key. The system provides two methods to view history records.

- (1) All History is used to view the latest 500 system running messages including startup, shutdown, reset, fire alarm, pre-alarm, supervisory, action, delay, fault and disabled messages. The maximum capacity is 500 entries.
- (2) Fire History is used to view the latest 999 fire messages. The maximum capacity is 999 entries.

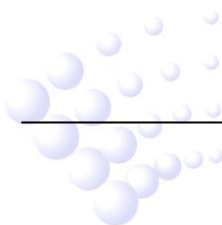

Fig. 6-1

#### 6.3.1 Viewing All Messages

In the screen shown in Fig. 6-1, selecting "1. All History", the system will enter the screen of viewing history records.

In this screen, the latest 500 events can be viewed, which include event type, serial number, total number, location, time and device type (Fig. 6-2).





Fire	001/043 2-031 15/12 10:15	
Fault	002/043 2-023 15/12 13:26	

Fig. 6-2

### 6.3.2 Viewing Fire Messages

In the screen shown in Fig. 6-1, selecting “2.Fire History”, the system will enter the screen of viewing fire records.

The latest 999 fire messages can be viewed under this screen, which include serial number, total number, location, time and device type (Fig. 6-3).

Fire	001/043 2-031 15/12 13:26	
Fire	002/043 2-023 15/12 13:26	

Fig. 6-3

### 6.4 Viewing System Devices

You can view devices connected into the system by pressing *Browse* (Fig. 6-4).

The first screen

1. Active Equ.
2. Net Unit

The second screen

3. Repeater

Fig. 6-4

#### 6.4.1 Loop Devices

In the screen shown in Fig. 6-4, selecting “1. Active Equ.”, the system will enter the screen to view loop devices, where you can view all on line loop devices including total devices on line, location and device type.

You can input the device code in the cell after “Code”, or pressing the up and down key to view

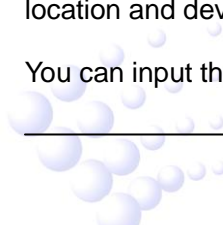

the device before or after it.

In Fig. 6-5, we can see there are 98 devices on line and the current device No. 232 is in Zone 8 which is a manual call point.



Fig. 6-5

For digital detector, there will be a “->” at the right bottom of the screen, indicating you can enter the following screen by pressing *Enter*.



Fig. 6-6

In Fig. 6-6, we can see there are 98 devices on line and the current device No. 135 is in Zone 5 which is a digital smoke detector. Pressing *Enter*, the screen displays as follows:

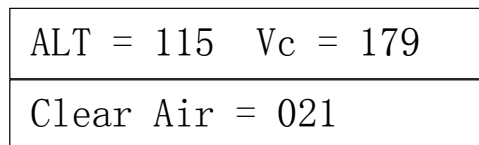

Fig. 6-7

In the above screen, ALT (Alarm Threshold) refer to alarm threshold which is related with the detector’s sensitivity. Vc (Current Value) refers to the current sampled value. “Clear Air” value refers to the initial background light, which is a calibrated value under a reference testing environment.

#### 6.4.2 Viewing Network FACP

In the screen of Fig. 6-4, moving the highlight to “2. Net Unit” and pressing *Enter* or using number key 2, the system will enter the screen of viewing network units which includes the quantity and number of the FACP in the network.

#### 6.4.3 Viewing Repeater Panels

In the screen of Fig. 6-4, moving the highlight to “3. Repeater” and pressing *Enter* or using number key 3, the system will enter the screen of viewing repeater panels which includes the quantity and number of the repeater panels on line.

### 6.5 Disabling and Enabling Devices

Pressing *Disable* or *Enable*, the system displays the following:

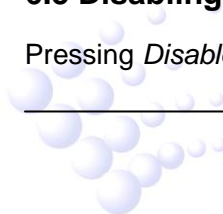

The first screen



The second screen



The third screen



Fig. 6-8

Operations that can be disabled and enabled are:

- (1)Zone: Disabling/enabling all devices of a zone.
- (2)Devices: Disabling/enabling an individual device.
- (3)Outputs: Disabling/enabling a selected output so that it cannot be triggered.
- (4)Pre-Alarm: Disabling/enabling the pre-alarm mode of detectors.
- (5)Output Delays: Disabling/enabling output delay.

If there is a device in trouble or false alarm, you can disable it so that it's separated from registered devices. After it's repaired or replaced, you can then enable it again and the FACP will add it to registered devices.

### 6.5.1 Disabling / Enabling a Zone

In the screen of Fig. 6-8, selecting "1. Zone", the system will display zonal disable screen as in Fig. 6-9.

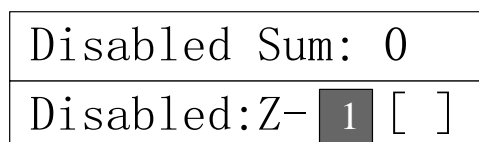
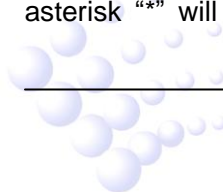

Fig. 6-9

Input the zone number, and press *Enter*, all devices of the zone will be disabled and an asterisk "\*" will appear in the "[ ]". The zonal *Flt/Disabled* LED illuminates. The first line



(Disabled Sum) which is the total number of disabled zone will increase by 1. The zone number will also increase by 1 (if the disabled zone is zone 8, it changes to zone 1) as shown in Fig. 6-10. Pressing the up key can view the disabled zone, as in Fig. 6-11.

Disabled Sum: 1
Disabled:Z- 2 [ ]

Fig. 6-10

Disabled Sum: 1
Disabled:Z- 1 [*]

Fig. 6-11

The operation method of enabling a zone is similar to disabling a zone.

### 6.5.2 Disabling / Enabling a device

Selecting “2. Devices” in the screen of Fig. 6-8, the system will enter the screen for disabling an individual zone, as in Fig. 6-12.

You can input the device code to be disabled in the cell after “Code”, or pressing the up and down key to select the device before or after it. The second line displays the device information. Pressing *Enter*, the selected device will be disabled.

**Note: An already disabled device will not be displayed here.**

Code: 231 Sum:002
8-231 Digital 

Fig. 6-12

The operation method of enabling a device is similar to disabling it.

### 6.5.3 Disabling / Enabling an Output

The outputs that can be disabled and enabled are:

- (1) ALARM OUTPUT. ALARM OUTPUT includes fire output and supervisory output which share 1 relay output circuit and 1 LED. Only when both fire output and supervisory output are disabled, the *Fire Output* LED indicates the disabled state that is the red and green LED both illuminate.
- (2) SOUNDER OUTPUT (R+, R-). There is a SOUNDER OUTPUT circuit and an LED for the SOUNDER OUTPUT.

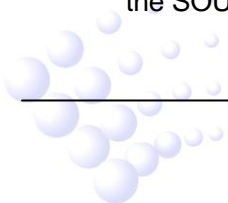

- (3) FAULT OUTPUT: There is a FAULT OUTPUT circuit and an LED for the FAULT OUTPUT.

Selecting “3. Outputs” in the screen of Fig. 6-8 will enter the screen for setting the output status, as in Fig. 6-13.

The first screen

Fire Out	[*]
Abnormal Out	[ ]

The second screen

Sounder Out	[*]
Fault Out	[*]

Fig. 6-13

[\*] represents the output is currently enabled, and [ ] represents the output is disabled.

Pressing *Enter* in disabled screen, it displays “[ ]” showing the output is disabled. If an output is already disabled (displaying “[ ]”, it remains unchanged when *Enter* is pressed. Pressing *Enter* in enabled screen, it displays “[\*]”. If an output is already enabled (displaying “[\*]”, it remains unchanged when *Enter* is pressed.

#### 6.5.4 Disabling / Enabling Pre-alarm

As described in Section 5.6, an alarm from a detector will be considered as a pre-alarm signal if the FACP works in delay mode while pre-alarm is enabled.

Selecting “4. Pre-Alarm” in the screen of Fig. 6-8, will enter the screen for enabling pre-alarm as shown in Fig. 6-14.

Pre-Alarm	[*]

Fig. 6-14

[\*] represents the pre-alarm is currently enabled, and [ ] represents it is disabled.

Pressing *Enter* in disabled screen, it displays “[ ]” showing the output is disabled. If the pre-alarm is already disabled (displaying “[ ]”, it remains unchanged when *Enter* is pressed. Pressing *Enter* in enabled screen, it displays “[\*]”. If the pre-alarm is already enabled (displaying “[\*]”, it remains unchanged when *Enter* is pressed.

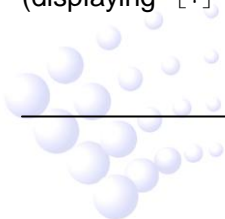

### 6.5.5 Disabling / Enabling Output Delay

If output delay is enabled, the control panel can delay the output of the sounders, ALARM OUTPUT (fire alarm output, supervisory output) and SOUNDER OUTPUT (R+, R-) (the FAULT OUTPUT cannot be delayed).

**Note: the Output delay is normally enabled in order to reduce the false action of the sounders ALARM OUTPUT and SOUNDER OUTPUT (R+, R-).**

Selecting “5. Output Delays” in the screen of Fig. 6-8 will enter the screen for setting output delay, as in Fig. 6-15.



Fig. 6-15

[\*] represents the output delay is currently enabled, and [ ] represents it is disabled.

Pressing *Enter* in disabled screen, it displays “[ ]” showing the output is disabled. If the output delay is already disabled (displaying “[ ]”, it remains unchanged when *Enter* is pressed. Pressing *Enter* in enabled screen, it displays “[\*]”. If the output delay is already enabled (displaying “[\*]”, it remains unchanged when *Enter* is pressed.

### 6.6 Users Settings

In User screen, the user can modify the printing mode, modify system time, set delay time and network address.

Pressing *User* can enter the user setting screen as in Fig. 6-16.

The first screen



The second screen



Fig. 6-16

#### 6.6.1 Printer Setup

The printer can be set to the following three modes:

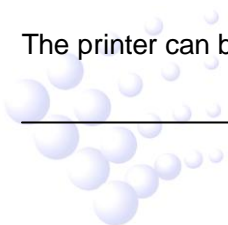

- (1) Disabled: No message will be printed out.
- (2) Print Fire: Only fire alarm messages will be printed out.
- (3) Print All: All messages will be printed out.

Selecting “1. Printer Setup” in the screen of Fig. 6-8, will enter the screen for setting the printer as in Fig. 6-17.

The first screen



The second screen



Fig. 6-17

[\*] represents the mode is enabled, and [ ] represents it is disabled.

Highlighting a mode and pressing *Enter*, the mode will be enabled and “[\*]” will be displayed.

### 6.6.2 Time Setup

Time setup is used for setting and calibrating system time, which can be detailed to year, month, date, hour and minute.

**Note: The time must be set accurately as it will be used as reference time for system running records.**

Selecting “2. Time Setup” in the screen of Fig. 6-8 will enter time setup screen as shown in Fig. 6-18.

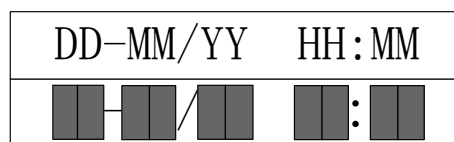
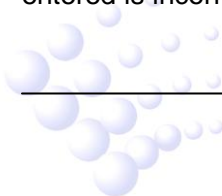

Fig. 6-18

The screen display the time by date-month/year hour: minute (DD: date, MM: month, YY: year, HH: hour, MM: minute).

The control panel will return to the previous window after new time is entered. If the time entered is incorrect, the system doesn't respond and waits for new input.



### 6.6.3 Delay Setup

Selecting “3. Delay Setup” in the screen of Fig. 6-8 will enter delay setup screen shown in Fig. 6-19.



Fig. 6-19

- (1) Zone/STG 1: If pre-alarm is enabled, this is for setting the delay time of the first stage of pre-alarm. If pre-alarm is disabled, this is for setting the output delay time for the zonal sounders, which is maximum 600 seconds.
- (2) Common/STG 2: If pre-alarm is enabled, this is for setting the delay time of the second stage of pre-alarm. If pre-alarm is disabled, this is for setting the output delay time for the common sounders or ALARM OUTPUT and SOUNDER OUTPUT (R+, R-), which is maximum 600 seconds.

Selecting 1 or 2 in the screen of 6-19 will enter setting screen as in Fig .6-20.

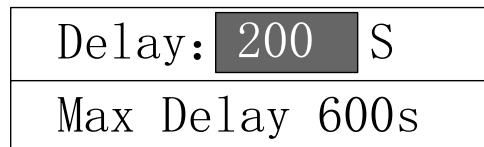

Fig. 6-20

### 6.6.4 Network Setup

Please refer to Chapter 8 for description of network setup.

### 6.7 Evacuate

If a fire alarm is acknowledged as a real fire, pressing *EVAC* key will immediately start all sounders and SOUNDER OUTPUT (R+, R-) to warn people to evacuate. Pressing *EVAC*, the system will request a password. Entering the correct password and pressing *Enter* will enable the evacuate function.

### 6.8 Alarm Silence

If a fire occurs, the zonal and common sounders will be activated to give the alarm sound.

Pressing *Silence* can stop the sound (if the keypad is locked, Level 1 password is required), and the *Silence* LED will illuminate. The second press on *Silence* key or a new-coming fire alarm will re-start the sounders, and the *Silence* LED goes off.

### 6.9 Reset

The FACP shall be reset after a fire alarm or a fault is disposed. Reset can be done by pressing *Reset* key and inputting the password and pressing *Enter*.



The following functions can be realized by reset:

- (1) Clearing all current fire alarm and fault display;
- (2) Resetting the status indication LED of loop controlled fire suppression equipment.
- (3) Clearing the silenced status;
- (4) Locking the keypad.

## **6.10 Unlocking and Locking the Keypad**

### **6.10.1 Unlocking the Keypad**

The keypad is locked by default when powered up. Certain functional keys (except *Browse*) request a password and confirmation by pressing *Enter* before further operation.

### **6.10.2 Locking the Keypad**

The FACP is designed to automatically lock the keypad. When there are alarm messages such as fire, supervisory and fault being displayed or there is menu operation, the FACP will lock the keypad if there is no operation in 90 seconds and no new message comes.

**Note: After operations, the person on duty should make sure that the keypad is locked in order to avoid unwanted operation.**

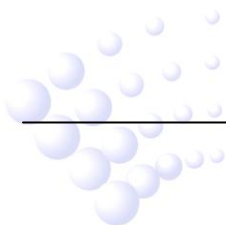

## Chapter 7 System Operator's Guide

System configuration can be modified by pressing *System* (Fig. 7-1) where Level 2 password is required.

The first screen



The second screen



The third screen

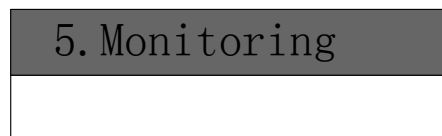

Fig. 7-1

### 7.1 System Status Setup

Pressing *System* and entering Level 2 password will enter system setup menu, and there will be a "-" at the right bottom of the screen showing the system is in commission status. About 2 minutes later the "-" will disappear and the screen changes to monitor status. Resetting the panel can also change the system from commission to monitor status.

Commission Status is used in project commission or the system configuration needs to be modified (such as the number of loop devices or network equipment). Registering devices in this status will update registration information and network configuration.

Monitor Status is the normal status after completion of project commission. Under this status registration information and network configuration cannot be updated.

### 7.2 Device Definition

Selecting "1. Definition" under the screen shown in Fig. 7-1 will enter the screen of device definition shown in Fig. 7-2.

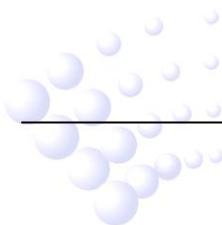

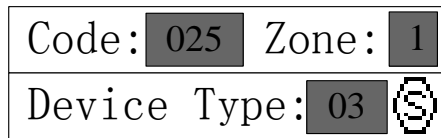

Fig. 7-2

You can input the device code after “Code”, and zone number after “Zone”, in which “0” stands for the common zone, and then input the device type. The icon of the device type will be displayed to avoid any possible mistake. Pressing *Enter* will complete the definition.

After a device is successfully defined, the following device code will automatically increase by 1, with other messages remaining unchanged. If the definition fails, the device code will remain unchanged for re-definition.

Inputting the device code in monitor status, its definition message is automatically displayed which can be modified by the user. Inputting the device code in commission status the initial value of the device will be displayed.

### 7.3 Device Registration

Selecting “2.Register” in the screen of Fig. 7-1 will enter the screen of device registration as in Fig. 7-3.

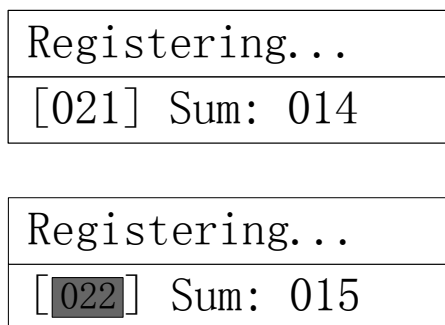
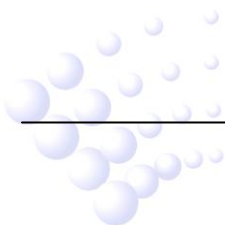

Fig. 7-3

The device code is displayed in the “[ ]” during device Registration. If the device code is highlighted, this means it is registered and the total number of registered devices increases. If the device number is not highlighted, then the device is not registered. The system enters normal monitoring state after registration.

We can see from Fig, 7-3, device No. 021 is not registered and the total number remains unchanged. Device No. 022 is registered and the total number increased by 1.

The FACP is able to identify duplicated codes and write into running record for the user to modify. If there are duplicated codes, the screen will display the following message after registration (Fig. 7-4).



Repeated! Please browse history!
-------------------------------------

Fig. 7-4

Disposal of duplicated codes:

- (1) Press *History* and select “All History” option;
- (2) The duplicated codes are shown as in Fig. 7-5, in which device No. 2 and 5 are duplicated.



Doub- le	001/020 1-002 15/12 13:26	
Doub- le	002/020 1-005 15/12 13:26	

Fig. 7-5

- (3) Modify the code to an unused number within 1~242 by handheld programmer. If it's a digital device, the “Code Modify” option of the FACP can be used (refer to Section 7.4.1).
- (4) Press *System* and select “2. Register” to re-register the device.

## 7.4 Password Setting

### 7.4.1 Classification of the passwords

Operation to functional keys except *View Fire*, *Tab*, *History*, and *Browse* requires password. Only after the correct password is input, further operation can be done. For system security, there are two levels of password, password I and password II.

Functions that can be performed by password I are User Setup, Disable/Enable, Self-test, Reset, Evacuate and Silence. Password II is used for system settings.

**Note: Password levels are downwards applicable (e.g. if a User enters the level 2 password, they have access at all levels).**

### 7.4.2 Modification of the password

Selecting “3.Password” in the screen of Fig. 7-1 will enter password setting screen as in Fig. 7-6.

1. Password I
2. Password II

Fig. 7-6

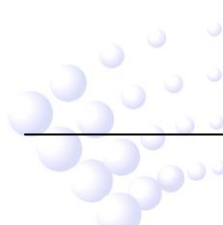

Press up and down key to select the item. After *Enter* is pressed, the system will enter the screen of password modification shown as Fig. 7-7.

Password:	*****
Confirm:	*****

Fig. 7-7

New password can be input here. The FACP will request to repeat the new password to avoid mistake.

If the two inputs are the same, the FACP will exit password setup screen, which means the setting is successful. If they are different, the screen remains unchanged and waits to be modified.

## 7.5 Device Modification

**Note: Device modification is only available for digital devices.**

Selecting “4.Device Modify” in the screen of Fig. 7-1 will enter the screen of device modification as in Fig. 7-8.

1. Code Modify
2. Sense Modify

Fig. 7-8

### 7.5.1 Code Modification

Selecting “1.Code Modify” in the above screen will enter the screen in Fig. 7-9.

Old Code:	123
New Code:	210

Fig. 7-9

Input the device code after “Old Code” and the modified code after “New Code”, and then press *Enter*. If the modification is successful, the screen will display as in Fig. 7-10.

Succeed!

Fig. 7-10

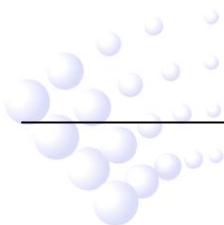

If the input code is beyond the available range or if the modification is unsuccessful, the screen will remain unchanged and waits to be modified.

### 7.5.2 Sensitivity Modification

Selecting “2.Sense Modify” in the screen of Fig. 7-6, the system will enter the screen in Fig. 7-11.

1. Zone Sense
2. Code Sense

Fig. 7-11

- (1) “Zone Sense” is used to modify the sensitivity of all detectors from a zone.
- (2) “Code Sense” is for a specific detector.

There are three sensitivity levels: 1. High (H) 2. Moderate (M) 3. Low (L)

Selecting “1. Zone Sense” will enter the screen shown in Fig. 7-12.

Zone: 1	Sense: 2	
1. H	2. M	3. L

Fig. 7-12

**Note: The sensitivity of all detectors of the selected zone will change after modification here.**

Selecting “2.Code Sense” in the screen of Fig. 7-9 will enter the screen in Fig. 7-13.

Code: 210	Zone: 6	
Sense: 1	H	

Fig. 7-13

**Note: The device sensitivity will change after modification here.**

### 7.6 Device Monitoring

Selecting “5.Monitoring” in the screen of Fig. 7-1 will enter the screen of device monitoring. If it is digital loop device, the screen will be as in Fig.7-14.

Code: 162	Digital
Value: [ 0204 ]	

Fig. 7-14

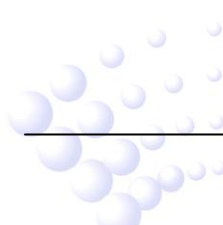

From the above figure we can see that digital device No. 162 is being monitored. The latest sampled value (temperature, smoke density and flame intensity) is 204.

If the device is non-digital loop device, the screen will be as Fig. 7-15.

Code: 003	Analog
Value: [ 1959 ]	

Fig. 7-15

The above screen shows that analogue device No. 162 is being monitored. The sampling value of its pulse duration of return code is 1959us.

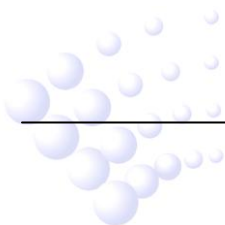

## Chapter 8 Networking

### 8.1 General Description

GST100 Fire Alarm Control Panel provides a multi-functional communication port which can connect it with GST series panels into network via a network card and with repeater panels.

### 8.2 Networking the FACP

#### 8.2.1 Network of GST Series Panels

The loop terminal of network card of GST series panels can be connected to the RS-485 loop. The loop cable shall be 1.0mm<sup>2</sup> or above twisted pair with total length not over 1Km.

#### 8.2.2 Connecting with Repeater Panels

The loop terminal of network card of the panel can be connected with the repeater panel via the RS-485 loop. The loop cable shall be 1.0mm<sup>2</sup> or above twisted pair with total length not over 1Km.

### 8.3 Networking Method

Reboot the panel after it's set to commission status, or pressing *Self Test* in commission status, the panel will automatically register network card. If the network card is properly connected, the screen will display as in Fig. 8-1.

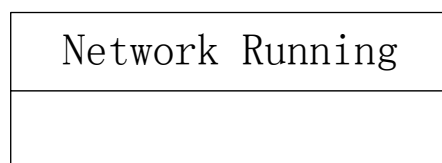

Fig. 8-1

#### 8.3.1 GST Network

GST Network is a special network for GST series control panels which can have all devices in the network be monitored. A maximum of 32 panels can be networked.

In order to network the panel, the panels shall be set with a network address first. The setting method of the network address for GST100 panel is as follows:

Pressing *User* and selecting "2. Local address" under "4. Network Setup" as in Fig. 8-2, and pressing *Enter* will enter the designated screen as in Fig. 8-3. Pressing *Enter* after setting, and then you can connect the panel into network via the network card. The address shall be within 01~32.

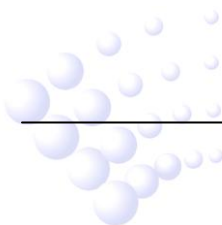





Fig. 8-2

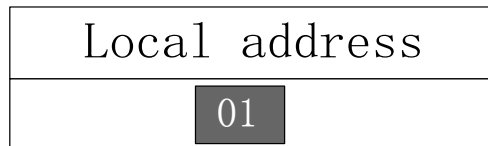

Fig. 8-3

As different system requires different network function, the FACP is designed to be able to filter network information. In this mode, The FACP displays only its local messages, but does not display messages from other network panels. The following settings will enable the filter ability:

Moving the highlight to “1. Display Setup” in the screen of Fig. 8-2 and pressing *Enter* will enter the screen as in Fig. 8-4. If “Enable” is selected, the FACP will display the fire, supervisory and fault message from the network. If “Disable” is selected, the FACP will display its local messages. (“[\*]” refers to the selected option).

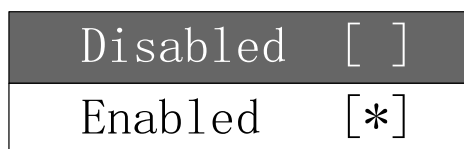

Fig. 8-4

If this FACP is used as the host panel and set in commission status (refer to Section 7.1), re-booting it after network address and display mode are set up will automatically update its network configuration.

### 8.3.2 Connecting with Repeater Panels

The FACP can connect with up to 64 repeater panels in order to transmit the fire alarm messages and give audio alarm.

The messages to be transmitted to the repeater panels are the location and code of the device that alarms the fire, so that the location can be quickly found.

## 8.4 Display of Network Messages

### 8.4.1 Network Fault

The FACP will report fault messages as shown in Fig. 8-5 and 8-6 in case there are power down with network panels and repeater panels, off-normal communication or damaged

network card. There are four types of network fault which are network card fault, telephone line fault in case the remote monitoring network doesn't work properly, network panel fault in case of the power down or off-normal communication with the network panels or repeater panels fault in case of power down with the repeater panels.



Fault	001/004 -----	
	15/03 13:28	
Fault	002/004 000000	
	15/03 13:29	

Fig. 8-5



Fault	003/004 000002	
	15/03 13:29	
Fault	004/004 000064	
	15/03 13:30	

Fig. 8-6

#### 8.4.2 Display of Network Messages

The FACP can display the fire, supervisory and fault messages from the network if the network display mode is enabled, as in Fig. 8-7 and 8-8. The user code of the device will be highlighted for network message. For local messages, only zone number and device code are displayed.



Last	002/002 021241	
Fire	15/03 13:27	
Fire	001/002 021221	
	15/03 13:26	

Fig. 8-7



Fault	001/002 032002	
	15/03 12:20	
Fault	002/002 032064	
	15/03 12:20	

Fig. 8-8



## Chapter 9 Calculation of Battery Capacity

Table 9-1

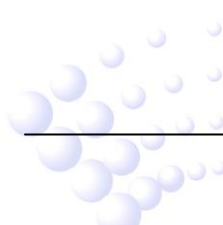
Device	Current (A)	
	Monitor	Alarm
FACP	0.1A	0.1A
Loop Devices	$N \times 0.0008A$	$N \times 0.002A$
Total	I1	I2

Suppose I3 is the sum of SOUNDER OUTPUT and auxiliary output which is maximum 1A, Tj (H) is the monitor time, Ta (H) is the alarm time, and Tw (H) is the output time.

The Maximum battery capacity (Ah)=  $I1 \times Tj + I2 \times Ta + I3 \times Tw$

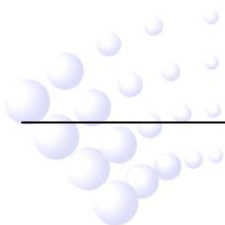

## Chapter 10 Troubleshooting and Regular Inspection

### 10.1 Common Disposal

Table 10-1

No.	Problem	Reason	Solution
1	No display or abnormal display after power up.	a. Abnormal power supply b. Loose connection with LCD cable.	a. Check 230VAC power supply b. Check the connection cable
2	Display AC Fault after power up	a. No 230VAC power supply b. The fuse of AC power is blown out.	a. Check and connect the cables. b. Replace the AC fuse. (see the label for parameter)
3	Display Battery fault after power up	a. Loose connection with battery. b. Battery discharged or damaged.	a. Check the relative parts. b. Power up for more than eight hours with the AC power supply, if the fault still exists, replace the batteries.
4	Unable to register field devices	a. Not well connected. b. The cable of field devices damaged.	a. Check and connect. b. Check and replace the cable.
5	Can not print	a. Print mode is not set. b. Loose connection with printer. c. Printer damaged.	a. Set the print mode. b. Check and connect the printer. c. Replace the printer.
6	Equipment fault	a. Loose connection with this equipment. b. This equipment damaged.	a. Check the connection. b. Replace the equipment.
7	Loop bus fault	Loop bus is shorted or open.	Check the circuit.

### 10.2 Maintenance of Printer

The printing paper should be replaced as required prior to running out.

- 1) Open the cabinet of FACP, and shut down the power (pull out the the 2P connector block connecting the printer and LED board.
- 2) Screw off the nut on the rack, take out the screw and remove the scroll spindle.
- 3) Put the new scroll spindle on the screw, replace and fix it with screws.
- 4) Cut the end of paper as in Fig. 10-1.

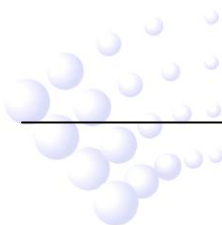

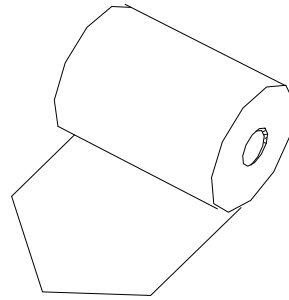
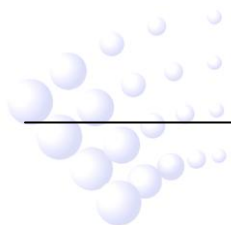

Fig. 10-1

- 5) Turn on the power of the printer. Press *SK1* key, feed the paper through by hand, the paper will enter slowly until it appears in front of the head. The scroll spindle has been replaced.







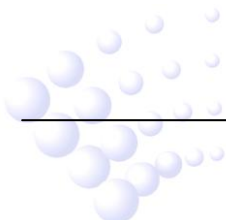
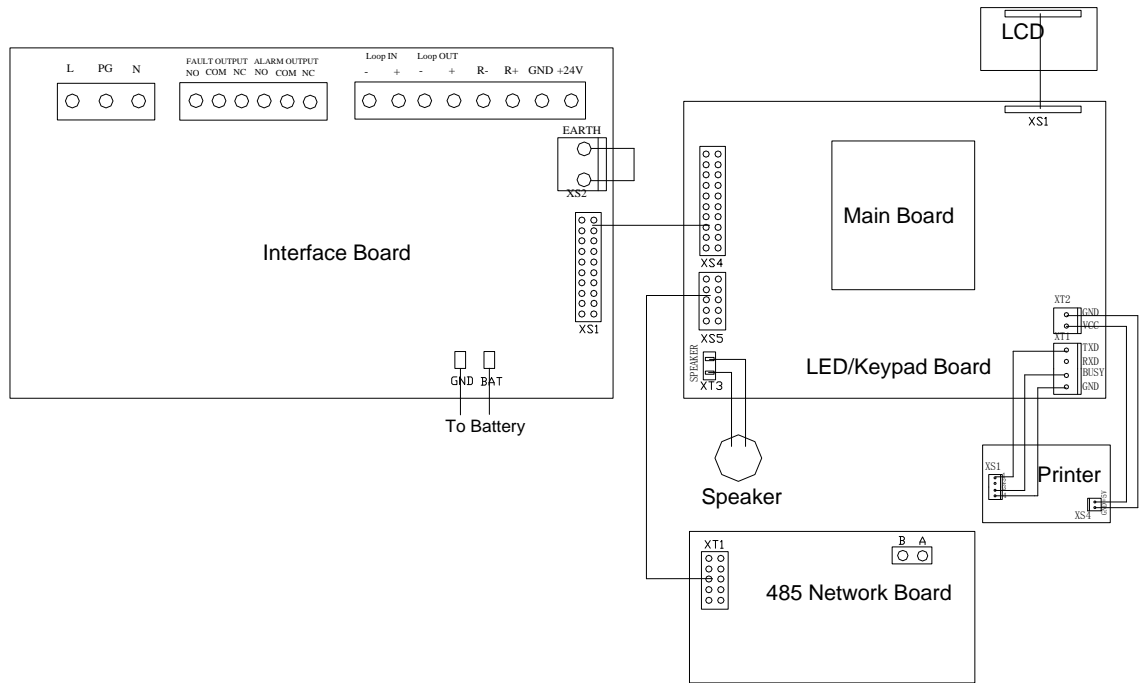









**Note: The printing paper should be always kept tight. The loose scroll will make it thicker thus slow the moving of paper.**



## Appendix 1 Internal Connection Diagram



## Appendix 2 Device Type List

	Device Type	No.	Action When Activity
	Undefined	00	Fire Alarm
	Smoke Detector	01	
	Heat Detector	02	
	Ultraviolet Flame Detector	07	
	Multi Detector	10	
	Ultraviolet Flame Detector	11	
	Infrared Beam Detector	51/52	
	Gas Detector	05	Supervisory
	Sounder	24/25	Action
	Flow SW	30	
	Alarm Output		
	Sounder Output		
	Fault Output		
	Power		Fault
	Battery		
	System Fault		
	Loop Bus Fault		
	Ground Fault		
	24V Fault		
	Net Card		

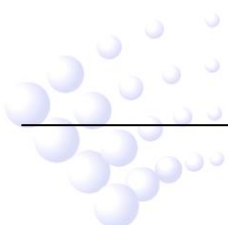



Gulf Security Technology Co., Ltd.

No. 80, Changjiang East Road, QETDZ, Qinhuangdao, Hebei,

P. R. China 066004

Tel: +86 (0) 335 8502434

Fax: +86 (0) 335 8502532

[service.gst@fs.utc.com](mailto:service.gst@fs.utc.com)

[www.gst.com.cn](http://www.gst.com.cn)