

GST303/GST306 Extinguishing Control Panel



Installation and Operation Manual

Issue 3.03 May 2012
ERP:30307751

CONTENTS

1	General	1
2	Features	1
3	Technical Specifications	1
4	Structure and Operation Principle	2
4.1	Structure	2
4.1.1	Front Panel	3
4.1.2	Internal Structure	4
4.2	Operation Principle	8
5	Mounting and Commission	8
5.1	Unpacking and Inspecting	8
5.2	Mounting	9
5.3	Terminals	10
5.4	Wiring	11
5.5	System Connection	11
5.6	Setting	12
5.6.1	Setting Address of Zone Control Board	12
5.6.2	Setting the Initial Address	12
5.6.3	Setting Delay Time	13
5.6.4	Setting Control Command Output	14
5.6.5	Setting Self-answer Mode	14
5.7	Commission	14
5.7.1	Commission of Delay Start	15
5.7.2	Commission of Immediate Start	15
5.7.3	Commission of Fault Display and Report	15
5.8	Installation of Protective Cover	16
6	Operation	16
6.1	Powering-up, Self-test and Switching off	16
6.2	Basic Operation	16
6.2.1	Start	16
6.2.2	Stop	18
6.2.3	Fault Indication	18
7	Troubleshooting	19
8	Caution	19
	Appendix 1: System Connection	21
	Appendix 2: How to Install Protective Cover	22
	Appendix 3: How to Start and Stop the Control Panel	24

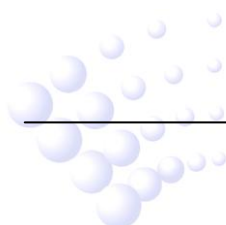

1 General

GST303/GST306 Extinguishing Control Panel (hereinafter called the control panel) is designed for driving the executing units of a fixed extinguishing system.

Except for 3 extinguishing zones less, and some minor differences in appearance and structure, GST303 is the same as GST306 in operation. We'll take GST306 as an example.

2 Features

The control panel can be directly connected to the loop of GST intelligent fire alarm control panels (FACP) that are able to control associated fire suppression equipment to achieve automatic control of gas release.

It can also control gas release devices independent of the FACP. When the FACP is not working properly, it can still control extinguishing devices through emergency gas override control in field or *Start* and *Stop* keys on the control panel.

This control panel is also able to monitor and alarm on short circuit or open circuit with external cables

3 Technical Specifications

- 1) Capacity:
 - GST303: Controlling maximum 3 extinguishing zones (3 control units)
 - GST306: Controlling maximum 6 extinguishing zones (6 control units)
- 2) Delay Time: 0s~45s, adjustable by every 5s
- 3) Wiring:
 - a 2-core connection with FACP.
 - b Two-wire connection with the solenoid of cylinder, pressure switch and gas extinguishing warning indicator.
 - c Three-wire connection with emergency gas override control.
 - d Two-wire connection with sounder strobe.
- 4) Power supply: Powered by external 20VDC~28VDC from intelligent PSU. Total length from PSU to the control panel and from the control panel to solenoid should not be over 100m, cross section not less than 2.5mm².
- 5) Solenoid Interface:

Start output: By pulse or electric level mode. 5s for pulse mode; Voltage range: 18VDC~26VDC; Maximum current: 2A
- 6) Gas Extinguishing Warning Indicator Interface:

Start output: Voltage range: 18VDC~26VDC; Maximum current: 300mA
Load: Maximum 5 for each zone.
- 7) C-9316 Gas Stop Indicator Interface:

Start Output: Voltage: 18VDC~26VDC; Maximum Current: 100mA
Load: Maximum 3 for each zone.
- 8) Sounder Strobe Interface:

Volt-free contact output; Maximum current allowed: 1A

- 9) Emergency Gas Override Control:
Load: Maximum 5 for each zone.
- 10) Standby Power Consumption $\leq 10W$
- 11) Operating Environment:
Temperature: $0^{\circ}C \sim +40^{\circ}C$
Relative Humidity $\leq 95\%$, non-condensing
- 12) Dimension:
GST303: 385mm \times 444mm \times 149mm
GST306: 575mm \times 444mm \times 149mm

4 Structure and Operation Principle

4.1 Structure

This control panel is surface-mounted on the wall. It contains main board, zone control board, I/O board, filter board, *Start* key, *Stop* key and *Power* switch, etc. Appearances of the GST303 and GST306 control panels are shown in Fig. 4-1.

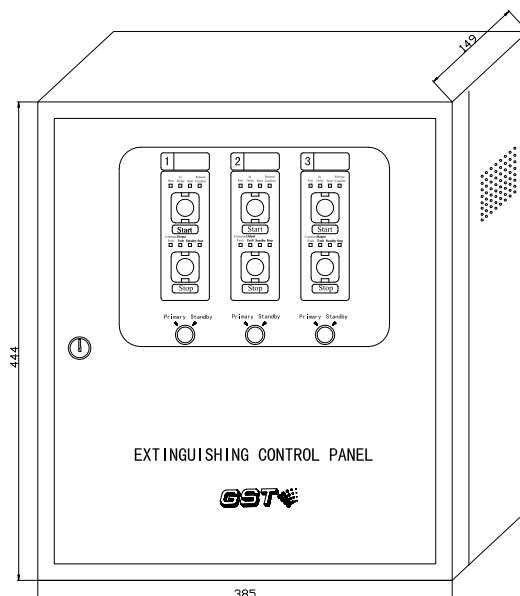
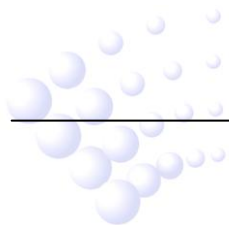

Fig. 4-1(a)



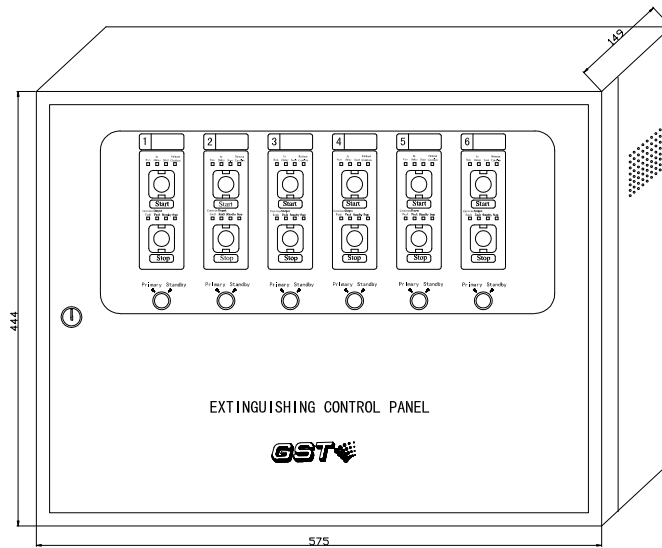

Fig. 4-1(b)

4.1.1 Front Panel

Front panel of GST306 is consisted of start/stop control panel (including *Start* key, *Stop* key and indicators), *Power* switch, *Reset* switch, and *Manual Start* key as shown in Fig. 4-2.

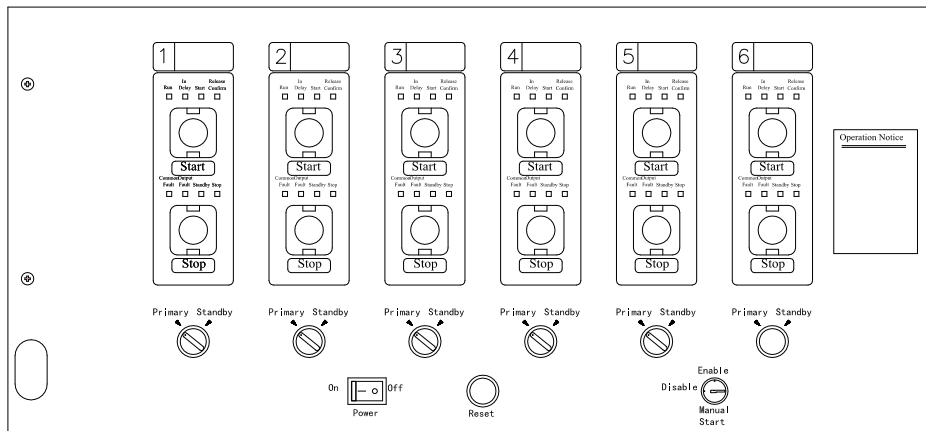

Fig. 4-2

Note: Power switch is only accessible when the door of the control panel is open.

- **Start** key: Non-self-lock key. When this key is pressed, GST306 will send gas release command to fire suppression devices immediately.
- **Stop** key: Self-lock key. When this key is pressed, the already sent delay start command will be stopped, and the control panel is reset to normal operation.
- **Run** LED: Green. It illuminates when 24VDC power is applied to the control panel and switched on.
- **In Delay** LED: Red. It illuminates when the FACP detects fire and gives gas release command, or field emergency gas override control is pressed and the control panel enters delay start state.
- **Start** LED: Red. It illuminates when start command is given (including

immediate start and delay start) and remains illuminating after relay output is activated.

- **Release Confirm** LED: Red. It illuminates when corresponding zonal pressure switch is activated.
- **Fault** LED: Yellow. It illuminates when connecting cable between the control panel and emergency gas override control or gas release warning indicator is in short or open circuit; or when connecting cable between the control panel and present primary or standby solenoid of cylinder is in short or open circuit, or when power supply is lower than 20V.
- **Output Fault** LED: Yellow. It illuminates when connecting cable between the control panel and primary or standby solenoid connected with gas extinguishing control relay module is in short or open circuit.
- **Standby** LED: Green. Reserved for later use.
- **Stop** LED: Green. It illuminates when stop command is sent out.
- **Power** switch: Switching on or off the power of the control panel.
- **Reset** switch: Pressing this key, the control panel will be reset, and all output signals will be stopped.
- **Manual Start** key: This key is to control manual keys on the front panel. The manual keys cannot be operated when this key is disabled.

4.1.2 Internal Structure

Internal structure of the control panel is shown in Fig. 4-3 (taking GST306 as an example). It shows the relative position of main board, zone control board, I/O board and filter board, etc. Internal connection is shown in Fig. 4-4.

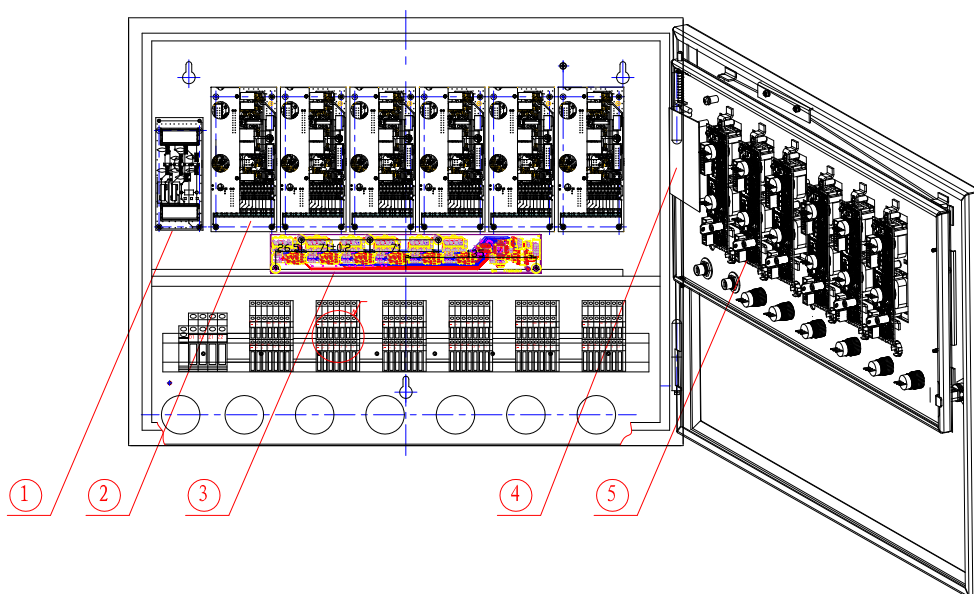
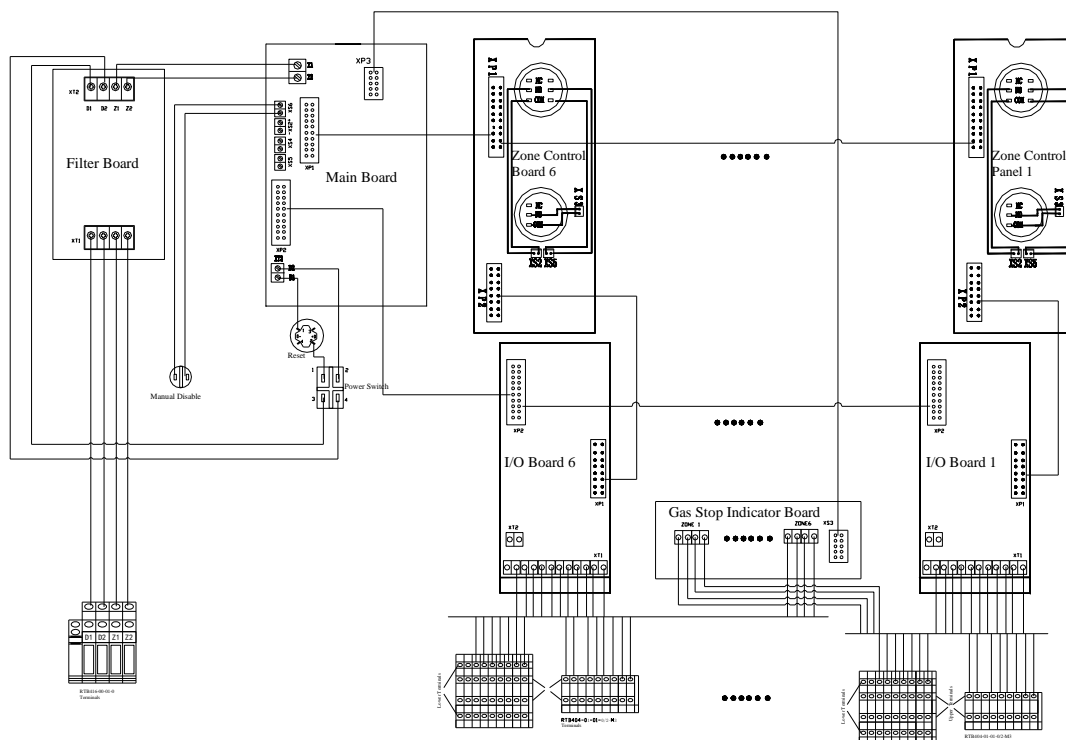

Fig. 4-3

- ① Filter board ② I/O board ③ Gas stop indicator board ④ Main board
⑤ Zone control board



Note: Please refer to marks on the terminals and I/O board for connection of XT1 with terminals.

Fig. 4-4

4.1.2.1 Main Board

Main board is the main control part of the panel, which is connected with the signal 2-core cable and zone control boards through respective terminals. Its structure is shown in Fig. 4-5.

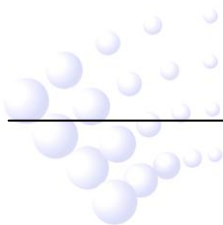

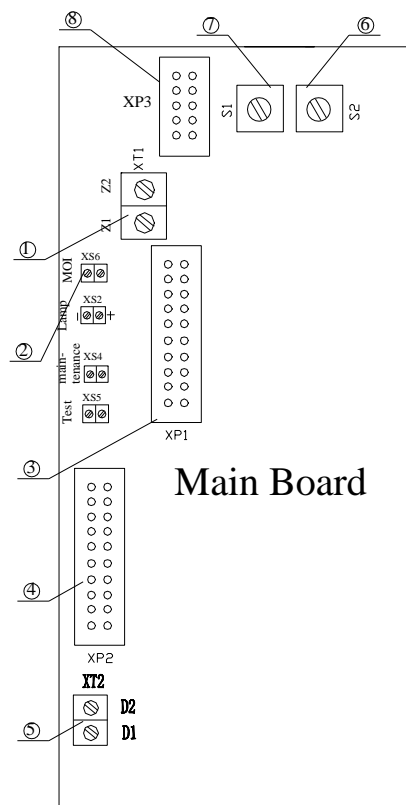

Fig. 4-5

- ① Loop terminals, connecting with signal cable.
- ② Terminal for connecting with *Manual Start* control key.
- ③ 20P ribbon cable socket, connecting with zone control board.
- ④ 20P ribbon cable socket, connecting with I/O board.
- ⑤ Power input, connecting with external 24VDC power.
- ⑥ Switch for setting up delay time of the control panel.
- ⑦ Switch for setting up initial address code of the control panel.
- ⑧ Gas stop indicator terminal, connecting with gas stop indicator control board.

Note: Please refer to Section 5.6 for setting method of pins and switches.

4.1.2.2 Zone Control Board

Each zone control board controls one protection zone. Its modular structure is shown in Fig. 4-6.

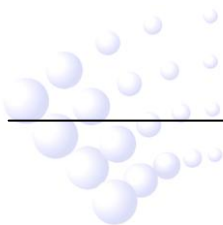

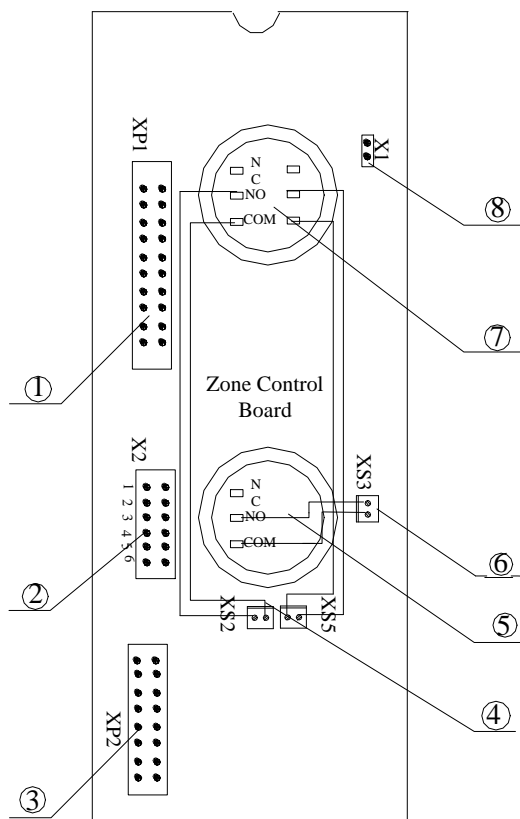
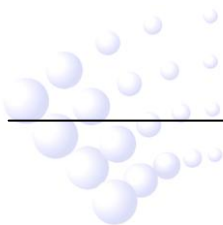

Fig. 4-6

- ① 20P ribbon cable socket connecting with main board
- ② Setting pin for zone control board
- ③ 16P ribbon cable socket, connecting with I/O board
- ④ Connecting with *Start* key
- ⑤ *Stop* key
- ⑥ Connecting with *Stop* key
- ⑦ *Start* key
- ⑧ Setting pin for self-answer mode

Note: Please refer to Section 5.6 for setting method of the pins.



4.1.2.3 I/O Board

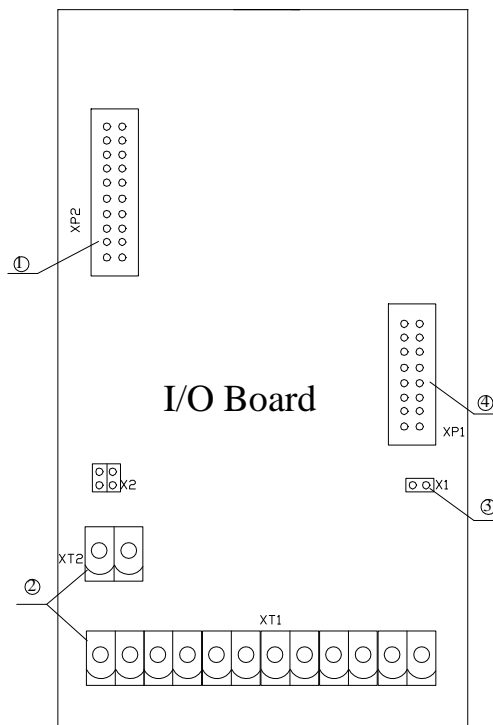

Fig. 4-7

- ① 20P ribbon cable socket connecting with main board.
- ② Terminals connecting input and output.
- ③ Pins for setting gas extinguishing output mode: Pulse mode in open circuit, and electric level in short circuit.
- ④ 16P ribbon cable socket, connecting with zone control board.

Note: Please refer to Section 5.6 for setting method of the pins.

4.2 Operation Principle

The control panel works on multi-wire mode. It connects with external devices such as solenoid, C-9317 Emergency Gas Override Control, I-9402 Sounder Strobe, C-9318 Gas Extinguishing Warning Indicator and C-9316 Gas Stop Indicator through multi-wire. It can also be connected to polarity-insensitive loop of fire alarm control panel (which should be able to control fire suppression devices) to form an extinguishing control system integrating fire alarm and fire suppression.

5 Mounting and Commission

5.1 Unpacking and Inspecting

Check the items against the packing list. Open the package and check whether installation and operation manual, key to the control panel and accessories have come with the control panel. Then inspect the appearance of the control panel.

Check internal configuration with reference to Chapter 4. Check the connection of different parts and make necessary records for use in installation and commission.

5.2 Mounting

GST303, GST306 are wall-mounted. Their dimensions are shown in Fig. 5-1a and Fig.5-1b.

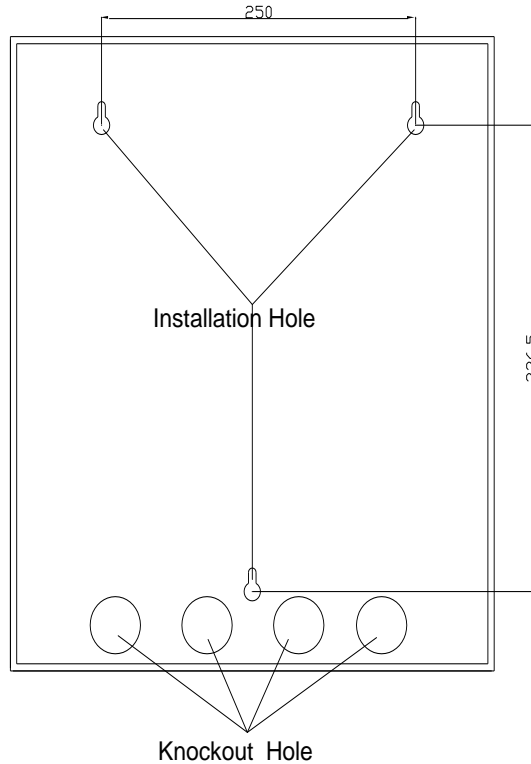

Fig.5-1a

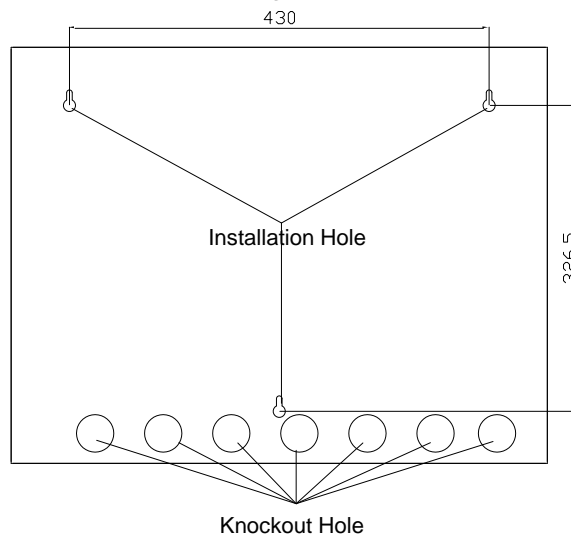
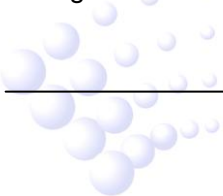

Fig. 5-1b

When the conduit comes from the ceiling, the control panel is supported by a bracket. And the conduit goes into the cabinet through the knockout hole at the back, as shown in Fig. 5-2a. When the conduit does not come from the ceiling, it goes into the cabinet through the knockout hole at the bottom as shown in Fig. 5-2 b.



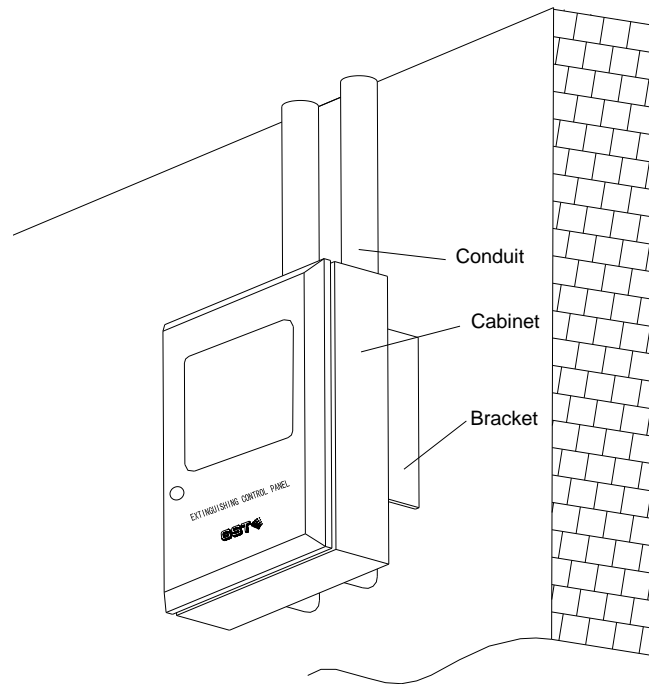

Fig. 5-2 a)

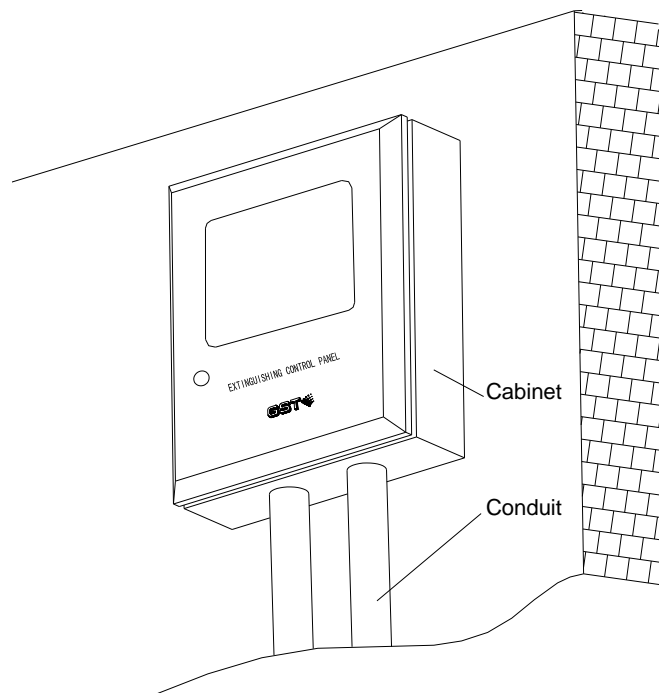
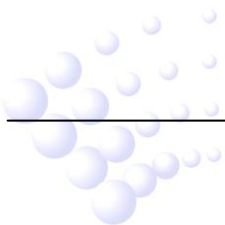

Fig. 5-2 b)

5.3 Terminals

All external wires are connected to the control panel through I/O board or filter. Terminals are shown in Fig. 5-3.



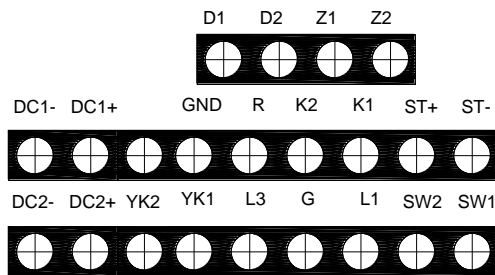

Fig. 5-3

D1, D2: Power input, polarity-insensitive.

Z1, Z2: FACP loop input terminal, polarity-insensitive.

DC1-, DC1+: Extinguishing start terminal, to gas extinguishing relay module.

GND, R: To C-9318 Gas Extinguishing Warning Indicator. A 4.7K/0.5W cable-checking resistor is to be connected to the end.

K2, K1: To sounder strobe

DC2-, DC2+: Reserved for future use.

YK2, YK1: To gas extinguishing relay module.

L3, G, L1: To field C-9317 Emergency Gas Override Control. A 4.7K/0.5W cable-checking resistor is to be connected between L3/G and L1/G respectively.

ST+, ST-: Gas Stop Indicator, polarity-sensitive. A 4.7K/0.5W cable-checking resistor is to be connected to the end.

SW1, SW2: To the switch of the door to the protected zone, polarity-insensitive. It should be normally-closed signal that is broken when the door is open. A 4.7K/0.5W cable-checking resistor is to be connected to the end.

Note: When multiple C-9318 Extinguishing Warning Indicators are connected in series, the furthest end-of-line resistor should be connected.

5.4 Wiring

- (1) 1.0mm² or above twisted pair flame-retardant insulation cables for signal loop Z1, Z2.
- (2) 1.0mm² or above RV cable for L3, G, L1, K1, K2, YK1, YK2, SW1 and SW2.
- (3) 1.5 mm² or above RV cable for R and GND.
- (4) 2.5mm² or above RV cable for power cable D1, D2, DC1+ and DC1-.

5.5 System Connection

- (1) The extinguishing device and pressure switch of each protected zone (connecting with C-9329 Gas Extinguishing Relay Module) are respectively connected to the corresponding terminals on the control panel by two-wire. Cabling of different zones should not be mixed.
- (2) Gas extinguishing warning indicator should be connected to corresponding terminals of the control panel by two-wire mode. Cabling of different zones should not be mixed. When there are two Indicators in the same zone, they can be connected in series.
- (3) Emergency gas override control is connected to the corresponding terminals of the control panel by three-wire mode. Cabling of different zones should not be mixed.

When there are several emergency gas override controls, they should be connected in series.

- (4) Sounder strobe are to be connected to the control panel by two-wire mode, to signal loop by polarity-insensitive two-wire, and to 24VDC power by polarity-insensitive two-wire.

Please refer to Appendix 1 for system connection.



Note:

- **When cabling the emergency start and emergency stop buttons of emergency gas override control, make sure to connect them according to the marks on the control panel and emergency gas override control. If they are reversed, the control panel will not give fault signal of connection error, and it cannot operate properly.**
- **When cabling gas stop indicator, make sure to connect them according to the marks on the control panel and gas stop indicator. If they are reversed, the control panel will not give fault signal of connection error, and it cannot operate properly.**
- **Save the removed terminal resistor for future use.**

5.6 Setting

5.6.1 Setting Address of Zone Control Board

Each zone control board corresponds to a zone (1~6), so each zone has its own address. Opening the cabinet, there is a pin X2 with marks of 1, 2, 3, 4, 5, 6 on the left. Short the pin whose address is to be set by a jumper. In Fig. 5-4, it is set as number 4.

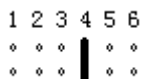

Fig. 5-4

Note: The address of zone control board cannot be set randomly. Please set one number to one board in sequence. It's not allowed to set several boards with the same number.

5.6.2 Setting the Initial Address

The control panel communicates with the FACP through polarity-insensitive signal loop. The initial address of the control panel on the FACP is set through code switch S1 on the main board of the control panel (Fig. 5-5). It can be set as 1, 21, 41, 61, 81, 101, 121, 141, 161, 181.

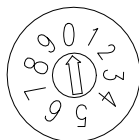

Fig. 5-5

To set initial address, open the cabinet, turn the code switch S1 on the main board to different positions according to initial address number. Details are shown in table 1.

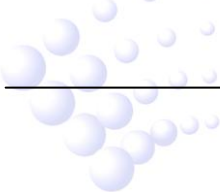

Table 1

Position of S1	0	1	2	3	4	5	6	7	8	9
Corresponding initial address	1	21	41	61	81	101	121	141	161	181

After the initial address is set, the addresses of control enable pin, emergency start button, emergency stop button, gas extinguishment and addresses reserved for future use will be automatically set in sequence according to the number of zone control board. No matter how many zones are configured to the control panel (1 ~ 6), control enable pin (alarming action when disabled) occupies an address, which is the initial address. Each zone occupies four addresses:

- (1) Emergency Start Button (action).
- (2) Emergency Stop Button (action).
- (3) Gas extinguishment (pressure switch action and local fault).
- (4) Reserved for future use.

The number of addresses occupied by the control panel = $n \times 4 + 1$ (n is the maximum quantity of zones, 1~6).

For example, in Fig. 5-5, S1 is set as 0, then the initial address is 1, in other words, the number of the control enable lock is 1. The addresses of other points are shown in Table 2.

Table 2

Zone Number		Address	Zone Number		Address
Zone No. 1	Emergency Start Button	2	Zone No. 4	Emergency Start Button	14
	Emergency Stop Button	3		Emergency Stop Button	15
	Gas extinguishment	4		Gas extinguishment	16
	Reserved	5		Reserved	17
Zone No. 2	Emergency Start Button	6	Zone No. 5	Emergency Start Button	18
	Emergency Stop Button	7		Emergency Stop Button	19
	Gas extinguishment	8		Gas extinguishment	20
	Reserved	9		Reserved	21
Zone No. 3	Emergency Start Button	10	Zone No. 6	Emergency Start Button	22
	Emergency Stop Button	11		Emergency Stop Button	23
	Gas extinguishment	12		Gas extinguishment	24
	Reserved	13		Reserved	25

5.6.3 Setting Delay Time

Because extinguishing device will finish gas release instantaneously on receiving valid start command, improper operation will result in great losses, even loss of life; On the other hand, it will affect the fire protective ability of some important places in a certain period. For these reasons, the control panel is designed with delay started feature. When receiving start request, it will delay for a certain time, and give command when delay ended. To meet requirements under different conditions, the delay time can be set by code switch S2 on the main board (see Fig. 5-6) within 0s~45s.

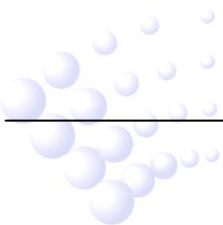

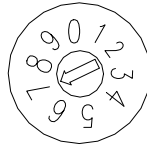

Fig. 5-6

To set the delay time, you can open the enclosure and turn code switch S2 on the main board. The different position of S2 corresponds to different delay time as in Table 3.

Table 3

Position of S2	0	1	2	3	4	5	6	7	8	9
Corresponding Delay Time (s)	0	5	10	15	20	25	30	35	40	45

For example, in Fig. 5-6, S2 is set at 7. The delay time of the control panel is 35s.

5.6.4 Setting Control Command Output

The control panel can be set to “pulse” or “electric level” mode to control different zones according to field condition. The method is: Short pin X1 on I/O board corresponding to a certain zone by a jumper to set to level mode; Remove the jumper to set to pulse mode.

5.6.5 Setting Self-answer Mode

To choose which action is to be reported in case there is no pressure switch, the answer mode of the control panel can be set as pressure switch answer or self-answer. When it's set as pressure switch answer, the control panel will only light extinguishing warning indicator on receipt of action signal of pressure switch; When it's set as self-answer mode, it lights extinguishing warning indicator as soon as it starts output. The method is: Short pin X1 of zone control board by a jumper to set to pressure switch mode. Remove the jumper to set to self-answer mode.



The directions in Section 5.6 are only for commissioning engineer. Never operate by yourself. Otherwise you will be responsible for any result.

5.7 Commission



The solenoid of cylinder will be started to trigger gas release when applied with 24V power. Do not connect the gas extinguishing relay module and solenoid when commissioning. Connect them after the control panel is commissioned. When the control panel is delayed and checks the action signal of pressure switch, it keeps alarming until it is reset.

Commission Tools: two 24VDC relays, one cable (20mm~40mm)

System Initial State: Consecutive zone address, delay time 30s, pressure switch answer mode.

If the extinguishing control panel is to be connected with a fire alarm control panel (FACP), the FACP will set the device types of the addresses occupied by the extinguish control panel it registered. Please refer to the manual of the FACP for the device type

codes.

After the system is properly connected (except for solenoid), do the whole commission.
Use 24VDC relay in position of solenoid.

5.7.1 Commission of Delay Start

- a) Press emergency start button, *In Delay* LED is lit, sounder strobe acts; the FACP reports “Emergency start” action.
- b) Press emergency stop button, *Stop* LED is lit, sounder strobe stops action; the FACP reports “Gas abort” action.
- c) Resume emergency stop button by a sucker, *Stop* LED goes out, sounder strobe acts; “Gas abort” action is canceled.
- d) When delay time ends, the control panel starts 24VDC relay, *Start* LED is constantly lit, 24VDC relay should hold for about 5s.
- e) Short pressure switch by a cable, *Release Confirm* LED is lit, external gas extinguishing warning indicator is lit; the FACP reports “Gas dump” action.
- f) Start the control panel from the FACP, *In Delay* LED is lit, sounder strobe acts.

5.7.2 Commission of Immediate Start

- a) Pressing the start button on the control panel, *Start* LED is constantly lit, and the control panel outputs starting level. For pulse output mode, the holding period for starting level is the same as the time you press the start key. In other words, you will have to keep pressing the start key until gas starts to release. For level output mode, a press to the key for about several hundred milliseconds is enough to trigger gas release, because the output circuit can be self-locked instantly and keep continuous output.
- b) Press the key on fireman’s control panel on the FACP corresponding to “Gas Dump” address, *Start* LED is constantly lit, 24VDC relay should hold for about 5 seconds.

5.7.3 Commission of Fault Display and Report

- a) Disconnect any cable between the control panel and emergency gas override control, *Common Fault* LED is lit, the FACP reports “Gas dump” fault.
- b) Short any two of the three terminals on emergency gas override control (L1, G, L3) by a cable, *Common Fault* LED is lit, the FACP reports “Gas dump” fault.
- c) Disconnect any of the cables with C-9329, *Common Fault* and *Output Fault* LED are lit, the FACP reports “Gas dump” fault.
- d) Disconnect any of the cables between the control panel and pressure switch, the *Common Fault* LED is lit, the FACP reports “Gas dump” fault.
- e) Disconnect any of the cables between the control panel and gas extinguishing warning indicator, *Common Fault* LED is lit, the FACP reports “Gas dump” fault.
- f) Short input end of gas extinguishing warning indicator by a cable, *Common Fault* LED is lit, the FACP reports “Gas dump” fault.
- g) Disconnect the control panel and gas stop indicator, the FACP reports “Gas

dump” fault.

- h) Disconnect any cable between control panel and protection door, the FACP reports “Gas dump” fault.

5.8 Installation of Protective Cover

After mounting and commission, install the protective cover for start key and stop key. Refer to Appendix 2 for installation method.

6 Operation

6.1 Powering-up, Self-test and Switching off

(1) Check the settings of the control panel according to Section 5.

(2) Power up the unit as follows:

- Turn on the primary and standby power.
- Turn on the power of the control panel. After the above operation, the control panel starts self-test on sound and LEDs. After self-test, it enters standby state.
- Turn on primary/standby power switch and *Run* switch of the FACP. It will register the address of the control panel. The quantity of address points occupied by gas extinguishing devices = the greatest zone number x 4 +1.
- Turn off the switches in reverse procedure of turning on.

6.2 Basic Operation

6.2.1 Start

Important: Because extinguishing device will finish gas extinguishing instantaneously on receiving valid start command, so improper operation will result in great losses beyond remedy, even loss of life; On the other hand, it will affect fire protective ability of some important places in a certain period. Be very careful when starting these devices!

Besides conditions of starting ordinary devices, starting extinguishing devices should also meet the following conditions:

- ① The personnel to start extinguishing devices must be well trained of the relative knowledge.
- ② Confirming the fire condition that extinguishing devices has to be started.
- ③ Confirming that people in the protected zone have been evacuated.

After extinguishing devices have been started, field pressure switch will feed back answer signal of device action, and gas extinguishing warning indicator is lit. The control panel reports action of extinguishing devices to the FACP.

There are two modes of starting extinguishing devices: immediate start and delay start.

a) Immediate Start

When personnel on duty have confirmed fire and people have been evacuated, extinguishing devices can be started immediately. The command can be given from the control panel or from the FACP.

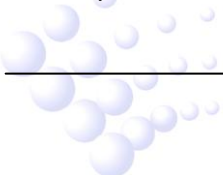

- When using the control panel, press the *Start* key corresponding to the alarming zone on the control panel to start extinguishing devices, and output starting level. Since the holding period for starting level is the same as the time you press the start key for pulse output mode, you will have to keep pressing the start key until gas starts to release.
- When using the FACP, there are two methods: from the keypad and from fireman's control panel. When the "start" key on main unit (input the addresses of the extinguishing devices and confirm) or the key on manual start panel is pressed, the FACP sends out start command immediately.

Using the "start" key on the keypad is a common method, which requires user code and types of connected extinguishing devices; using fireman's control panel is a special and quick method. It requires programming and defining the manual keys on fireman's control panel and their corresponding extinguishing devices when commissioning the FACP. When giving start command by fireman's control panel, press the manual key, command LED will be lit and start command will be sent out. Generally, it's recommended to use fireman's control panel as a quick method less possible to be mistaken. By this method, you can simply find the corresponding unit according to the indication on the keys of the fireman's control panel and then press its command key. Under special conditions, if the devices cannot be started through fireman's control panel, they can also be started through keyboard.

 **Note:**

- **As soon as the immediate start command is given, extinguishing devices will finish release instantaneously without a stop choice, so this operation should be carried out with caution.**
- **For pulse output mode, the holding period for starting level is the same as time you press the start key. In other words, you will have to keep pressing the start key until gas starts to release or for more than 5 seconds.**
- **For level output mode, output circuit can be instantly self-locked to keep continuous output, you only need to press the key for about 1 second. To reset the output, you will have to turn off the 24V power of the control panel.**
- **The start command must be given under "Manual Enable" and "Release Enable" states either you start the controlled devices through the keypad or through fireman's control panel of the FACP. When the FACP is in "Manual Disable" or "Release Disable" states or the device to be started is disabled or in fault state, the start operation is invalid.**
- **To start immediately, you need to press the central part of the protective cover, as shown in Appendix 3.**

b) Delay Start

Delay start mode enables the user to confirm if fire really occurs, and if people in the protective zone have been evacuated during the delay time to ensure safety of life and property.

Delay start control can be realized through field emergency start button and the FACP.

- When field emergency start button of protected zone is pressed, the control panel will enter delay start stage and report action of emergency start button to the FACP. The control panel will give start command after the delayed period. In this period, you can stop the command according to field situation. Please refer to section 5.6.3 for the setting of delay time.
- When detectors on the signal loop of the FACP detect fire, and when automatic start of fire suppression devices is enabled on the FACP, if only the cause and effect equation to start the extinguishing devices is valid, the FACP will give start command and the control panel will enters delay start state.
- In delay period, sounder strobes will be activated.

Delay start time of the control panel can be set within 0s~45s. The *In Delay* LED is lit during delay period.

Note: Delay start can only be done through the FACP in “Release Enable” state. When the FACP is in “Partially Automatic” state, cause and effect equations including “= =” take part in automatic start logic; in “Automatic” state, cause and effect equations including “=” and “= =” can take part in automatic start logic.

6.2.2 Stop

You can stop gas-extinguishing devices when they are in delay stage. According to field condition, different methods can be used:

- ① In delay period before start command is sent out, pressing “Stop” key of corresponding zone on the control panel can realize emergency stop of extinguishing devices.
- ② In delay period before start command is sent out, pressing field emergency stop button can realize emergency stop.
- ③ In delay period before start command is sent out, pressing “Start” key on keyboard of the FACP main unit and enter user code and device type of emergency stop device can realize emergency stop.
- ④ In delay period before start command is sent out, pressing the key on fireman’s control panel corresponding to “Gas abort” can realize emergency stop.
- ⑤ In delay period before start command is sent out, opening the door to the protected zone will temporarily stop gas extinguishing process. But please be aware that the start delay countdown will resume if there is still valid start signal. Any of the above four methods has to be used to stop gas extinguishing.

If the field emergency stop button or the Stop key is pressed, the control will report to the FACP action of the emergency stop button. After the stop command is sent out, *Stop* LED will illuminate, and the gas stop indicator in the protected zone will illuminate.

If the door to the protected zone is opened during the delay period, the gas stop indicator will illuminate. But if the door is opened in normal condition without delayed start, the gas stop indicator will not illuminate.

6.2.3 Fault Indication

When external devices or cable to the control panel are in fault, the control panel will report gas extinguishment fault (indicating fault in a certain zone).

- When the cable between the control panel and solenoid of cylinder connecting with gas extinguishing control relay module is in short or open circuit, it reports common fault and output fault; and *Common Fault* and *Output Fault* LEDs are lit.
- When the cable between the control panel and pressure switch is in short or open circuit, it reports common fault; and *Common Fault* LED is lit.
- When the cable between the control panel and emergency start/stop button is in short or open circuit, it reports common fault; and *Common Fault* LED is lit.
- When the cable between the control panel and gas extinguishing warning indicator is in short or open circuit, it reports common fault; and *Common Fault* LED is lit.
- When voltage of input power is lower than 20V, it reports common fault; and *Common Fault* LED is lit.

After the above fault is removed, the corresponding LED turns off and the control panel resumes proper operation.

Note: If there is short or broken circuit between the control panel and gas stop indicator, or open circuit with the door switch, the control panel will report the fault to FACP, but will not light its own fault indicator. After the fault is cleared, it reports the clearing message to the FACP.

7 Troubleshooting

Table 4

No.	Fault	Reason	Solution	Remarks
1	No self-test	Power supply incorrect; CPU doesn't work.	Check 24V power of the main board normal or not; 5V output normal or not;	Replace CPU when it doesn't work
2	Zone control board cannot be registered.	Address is not programmed.	Check setting pin X2 of zone control board number; Whether there is short circuit or open circuit; whether ribbon cables are in short circuit or open circuit.	

8 Caution

- (1) After installation and commissioning, the commission technician must check all jumpers and key covers meeting the requirements to ensure proper use.
- (2) After commission, measure with a multimeter to ensure there is no voltage before connecting with the circuit of solenoid. Illegal operation is prohibited!
- (3) Before powering up, check and fix all cable problems, such as short circuit, open circuit and incorrect connections etc.
- (4) The control panel generates audible alarm sound during the delay time, after delay start and after pressure switch action is detected until it's reset. It's considered abnormal if *Emergency Start* button is pressed within 10

- seconds after the control panel is reset. Then the control panel will start audible and visual alarm and report fault with *Emergency Start* button. In this case, the *Emergency Start* button and the control panel have to be reset.**
- (5) After start/stop operation through the control panel, the damaged key covers should be replaced in time; otherwise you should be responsible for any result.**
- (6) This panel is precise electronic product and must be maintained by designated personnel.**
- (7) We take the responsibility of repairing the control panel. Any problem occurs, please contact us in time. The users will be responsible for any result they made by disassembling or repairing it on their own.**

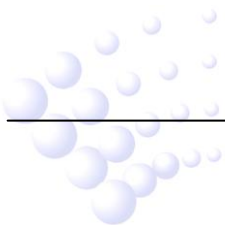

Appendix 1: System Connection

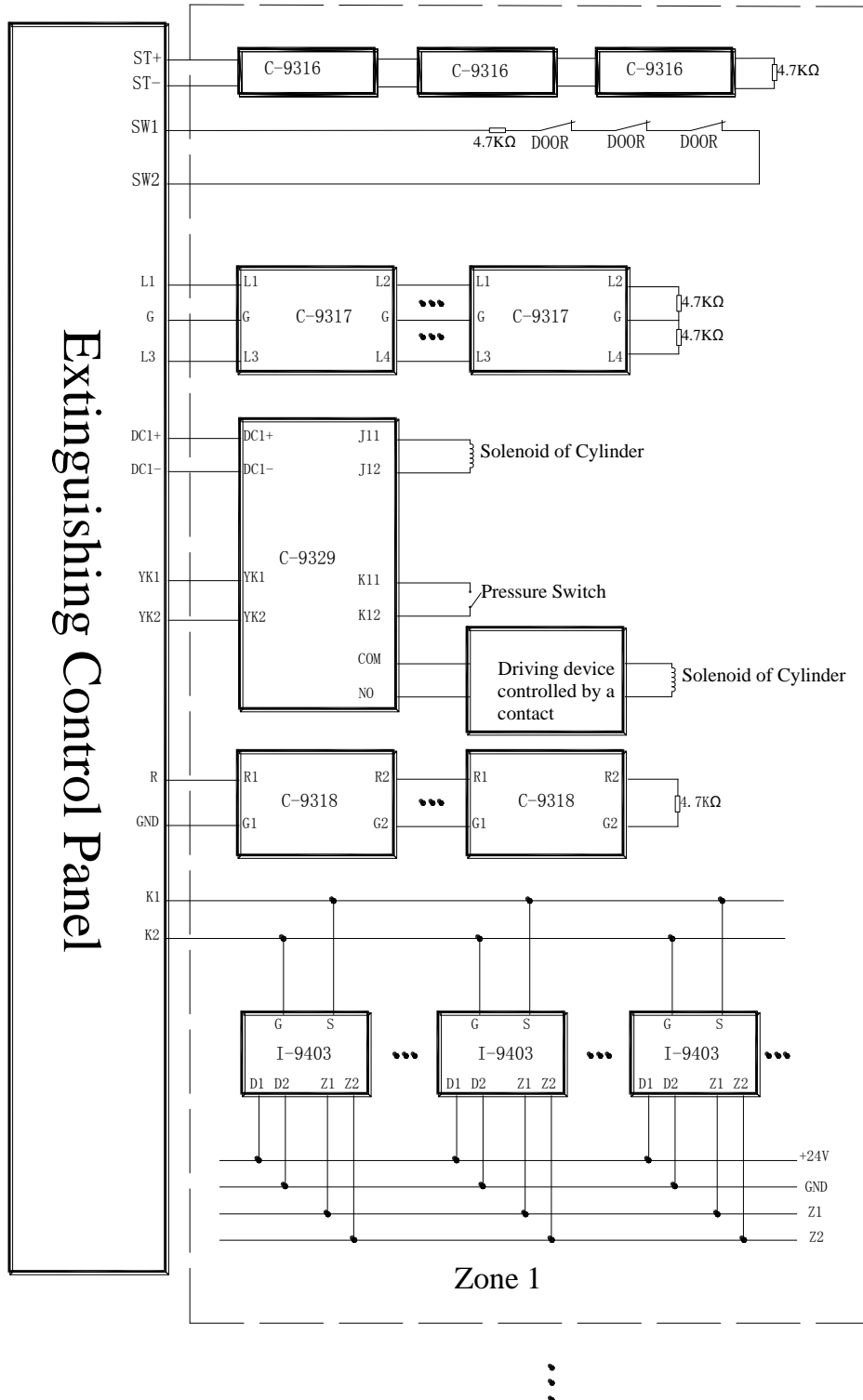

Fig. A-1

Note: I-9403 Sounder Strobe connecting K1 and K2 of the control panel can be replaced by I-9401 Sounder Strobe.

Appendix 2: How to Install Protective Cover

- 1) Aligning the two feet of the cover to the installation hole of the control panel, as in Fig. A-2 and Fig. A-3.

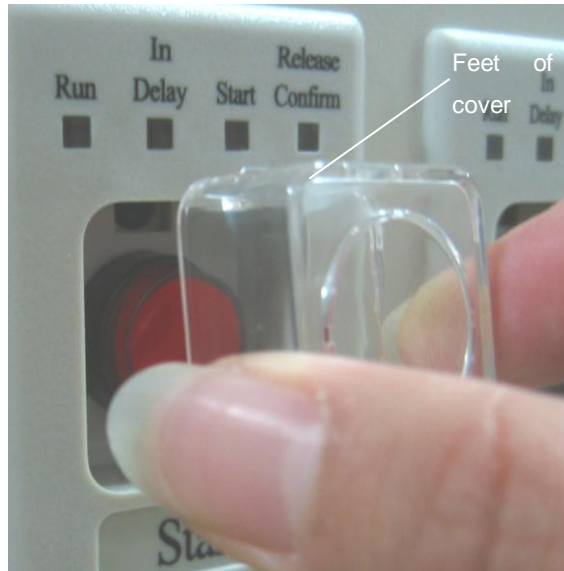

Fig. A-2



Fig. A-3

- 2) Push the feet into the hole horizontally, as in Fig. A-4 and Fig. A-5.

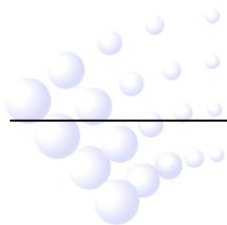



Fig. A-4



Fig. A-5

Note:

- Push the protective cover with balanced strength to ensure the two feet enter the holes simultaneously. Otherwise the cover will be damaged.
- Never use force to its central part (connecting with outer parts by tendons) to avoid damage to the cover.

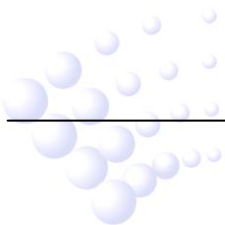

Appendix 3: How to Start and Stop the Control Panel

- 1) Covers are used to protect the start and stop key of the control panel in order to avoid unwanted operation. Press the center of the cover firmly as shown in Fig. A-6 to start or stop.



Fig. A-6

- 2) After start or stop operation, **please replace in time the protective cover to avoid any unwanted result!** Remove the damaged cover by pliers (see attached Fig. A-7, Fig. A-8 and Fig. A-9), then install the new cover according to instruction in Appendix 2.



Fig. A-7

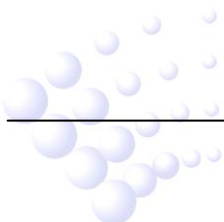
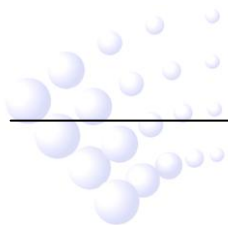



Fig. A-8



Fig. A-9



GST



Gulf Security Technology Co., Ltd.

No. 80, Changjiang East Road, QETDZ, Qinhuangdao, Hebei,

P. R. China 066004

Tel: +86 (0) 335 8502434

Fax: +86 (0) 335 8502532

service.gst@fs.utc.com

www.gst.com.cn